



CORONE PER CATENE A RULLI - DIN 8187 - ISO 606

PLATE WHEELS FOR ROLLER CHAINS - DIN 8187 - ISO 606

5 x 2,5 mm

Rullo 3,2 mm

03 - 1

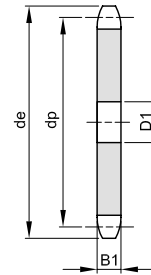
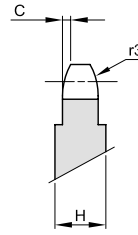
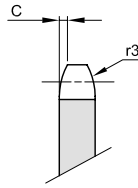

Da Z 51 H=4 mm

B1	B2	B3	b1	C	r3
2,3				0,4	5

Z	de	dp	semplici			doppi		
			codice	D1	Kg.	codice	D2	Kg.
8	14,8	13,06	201305008	4	0,01			
9	16,4	14,62	201305009	4	0,01			
10	17,9	16,18	201305010	4	0,01			
11	19,5	17,75	201305011	5	0,01			
12	21,1	19,32	201305012	5	0,01			
13	22,6	20,89	201305013	5	0,01			
14	24,2	22,47	201305014	5	0,01			
15	25,8	24,04	201305015	5	0,01			
16	27,4	25,63	201305016	6	0,01			
17	29,0	27,20	201305017	6	0,01			
18	30,5	28,79	201305018	6	0,01			
19	32,1	30,38	201305019	6	0,01			
20	33,7	31,96	201305020	6	0,01			
21	35,3	33,54	201305021	8	0,01			
22	36,9	35,13	201305022	8	0,02			
23	38,5	36,72	201305023	8	0,02			
24	40,1	38,30	201305024	8	0,02			
25	41,6	39,89	201305025	8	0,02			
26	43,2	41,48	201305026	8	0,02			
27	44,8	43,07	201305027	8	0,02			
28	46,4	44,65	201305028	8	0,03			
29	48,0	46,25						
30	49,6	47,83	201305030	8	0,03			
31	51,2	49,42						
32	52,8	51,01	201305032	8	0,03			
33	54,4	52,60	201305033	8	0,04			
34	55,9	54,19	201305034	8	0,04			
35	57,5	55,78	201305035	8	0,04			
36	59,1	57,37	201305036	8	0,04			
37	60,7	58,96	201305037	8	0,05			
38	62,3	60,54	201305038	8	0,05			
39	63,9	62,13						
40	65,5	63,73	201305040	8	0,05			
41	67,1	65,31						
42	68,7	66,91	201305042	8	0,06			
43	70,2	68,49						
44	71,8	70,09	201305044	8	0,07			
45	73,4	71,68	201305045	8	0,07			
46	75,0	73,27	201305046	8	0,07			
47	76,6	74,86						
48	78,2	76,45	201305048	8	0,08			
49	79,8	78,03						
50	81,4	79,63	201305050	8	0,08			
51	83,0	81,22						
52	84,6	82,81	201305052	10	0,17			
53	86,2	84,40						
54	87,7	85,97	201305054	10	0,18			
55	89,3	87,58	201305055	10	0,19			
56	90,9	89,17	201305056	10	0,20			
57	92,6	90,76	201305057	10	0,20			
58	94,1	92,35	201305058	10	0,21			
59	95,7	93,94						
60	97,3	95,53	201305060	10	0,23			
62	100,5	98,72	201305062	12	0,24			
64	103,7	101,90						
65	105,2	103,49	201305065	12	0,27			
66	106,8	105,08	201305066	12	0,28			
68	110,0	108,26						
70	113,2	111,44	201305070	12	0,31			
72	116,4	114,63						
75	121,2	119,40	201305075	12	0,36			
76	122,7	120,99	201305076	12	0,37			
78	125,9	124,17						
80	129,1	127,35	201305080	12	0,41			
85	137,1	135,31	201305085	14	0,46			
90	145,0	143,27	201305090	14	0,52			
95	153,0	151,22	201305095	14	0,58			
100	160,9	159,18	201305100	14	0,65			
110	176,8	175,09	201305110	14	0,79			
114	183,2	181,46	201305114	14	0,85			
120	192,8	191,01	201305120	14	0,95			
125	200,7	198,96	201305125	14	1,03			



CORONE PER CATENE A RULLI - DIN 8187 - ISO 606

PLATE WHEELS FOR ROLLER CHAINS - DIN 8187 - ISO 606

6 x 2,8 mm

Rullo 4 mm

04 - 1

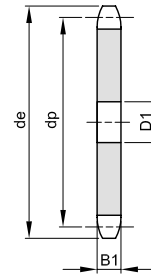
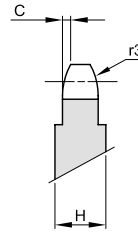
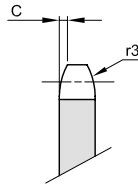

Da Z 51 H=4 mm

B1	B2	B3	b1	C	r3
2,6				0,6	6

Z	de	dp	semplici			doppi		
			codice	D1	Kg.	codice	D2	Kg.
8	18,0	15,67	201306008	5	0,01			
9	19,9	17,54	201306009	5	0,01			
10	21,7	19,42	201306010	6	0,01			
11	23,6	21,30	201306011	6	0,01			
12	25,4	23,18	201306012	6	0,01			
13	27,3	25,05	201306013	8	0,01			
14	29,2	26,96	201306014	8	0,01			
15	31,1	28,86	201306015	8	0,01			
16	33,0	30,76	201306016	8	0,01			
17	35,0	32,65	201306017	8	0,01			
18	36,9	34,55	201306018	8	0,02			
19	38,8	36,44	201306019	8	0,02			
20	40,7	38,44	201306020	8	0,02			
21	42,6	40,25	201306021	8	0,02			
22	44,5	42,16	201306022	8	0,02			
23	46,4	44,06	201306023	8	0,03			
24	48,3	45,96	201306024	8	0,03			
25	50,2	47,87	201306025	8	0,03			
26	52,1	49,77	201306026	8	0,03			
27	54,0	51,67	201306027	8	0,04			
28	55,9	53,58	201306028	8	0,04			
29	57,8	55,50						
30	59,8	57,42	201306030	8	0,05			
31	61,7	59,31						
32	63,6	61,21	201306032	10	0,05			
33	65,5	63,11	201306033	10	0,06			
34	67,4	65,02	201306034	10	0,06			
35	69,3	66,93	201306035	10	0,07			
36	71,2	68,84	201306036	10	0,07			
37	73,1	70,75	201306037	10	0,07			
38	75,0	72,66	201306038	10	0,08			
39	76,9	74,56						
40	78,9	76,47	201306040	10	0,09			
41	80,8	78,38						
42	82,7	80,28	201306042	12	0,10			
43	84,7	82,19						
44	86,6	84,10						
45	88,5	86,01	201306045	12	0,11			
46	90,4	87,92	201306046	12	0,12			
47	92,3	89,83						
48	94,2	91,74	201306048	12	0,13			
49	96,1	93,64						
50	98,0	95,55	201306050	12	0,14			
51	99,9	97,47						
52	101,8	99,37	201306052	12	0,25			
53	103,7	101,27						
54	105,6	103,17	201306054	12	0,26			
55	107,6	105,08	201306055	12	0,27			
56	109,5	107,00	201306056	12	0,28			
57	111,4	108,93	201306057	12	0,29			
58	113,3	110,82	201306058	12	0,30			
59	115,2	112,71						
60	117,5	114,62	201306060	12	0,33			
62	120,9	118,45	201306062	16	0,35			
64	124,7	122,27	201306064	16	0,37			
65	126,6	124,18	201306065	16	0,38			
66	128,5	126,09	201306066	16	0,40			
68	132,4	129,91						
70	136,2	133,73	201306070	16	0,45			
72	140,0	137,55						
75	145,7	143,28						
76	148,1	145,19	201306076	16	0,53			
78	151,5	149,01						
80	155,3	152,82	201306080	16	0,59			
85	164,8	162,37	201306085	16	0,67			
90	174,4	171,92	201306090	16	0,77			
95	183,9	181,47	201306095	16	0,85			
100	193,5	191,01	201306100	16	0,94			
110	211,6	210,11						
114	220,2	217,75	201306114	16	1,23			
120	231,7	229,20	201306120	16	1,37			
125	241,2	238,75	201306125	16	1,48			



CORONE PER CATENE A RULLI - DIN 8187 - ISO 606

PLATE WHEELS FOR ROLLER CHAINS - DIN 8187 - ISO 606

8 x 3,0 mm

Rullo 5 mm

05B - 1 - 2

B1	B2	B3	b1	C	r3
2,8	8,3		2,7	0,8	8

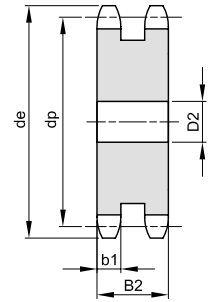
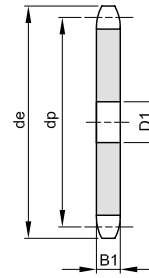
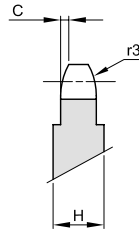
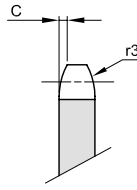

Da Z 46 H=4 mm

Z	de	dp	semplici			doppi			Z	de	dp	semplici			doppi		
			codice	D1	Kg.	codice	D2	Kg.				codice	D1	Kg.	codice	D2	Kg.
8	23,4	20,90	201308008	6	0,01	202308008	8	0,01	51	134,0	129,95						
9	25,9	23,39	201308009	6	0,01	202308009	8	0,01	52	136,6	132,49	201308052	16	0,43	202308052	16	0,82
10	28,4	25,89	201308010	8	0,01	202308010	8	0,02	53	139,1	135,04						
11	31,0	28,39	201308011	8	0,01	202308011	8	0,02	54	141,7	137,59	201308054	16	0,47			
12	33,7	30,91	201308012	8	0,01	202308012	8	0,03	55	144,2	140,13	201308055	16	0,49			
13	36,7	33,42	201308013	8	0,01	202308013	8	0,04	56	146,8	142,68				202308056	16	0,96
14	39,2	35,95	201308014	8	0,02	202308014	8	0,05	57	149,3	145,22	201308057	16	0,53	202308057	16	0,99
15	41,7	38,48	201308015	8	0,02	202308015	8	0,06	58	151,9	147,77	201308058	16	0,55			
16	44,2	41,01	201308016	8	0,02	202308016	10	0,07	59	154,5	150,31						
17	46,7	43,53	201308017	8	0,03	202308017	10	0,08	60	156,0	152,85	201308060	16	0,59	202308060	16	1,11
18	49,2	46,07	201308018	8	0,03	202308018	10	0,09	62	162,2	157,95	201308062	16	0,63			
19	51,7	48,61	201308019	8	0,03	202308019	10	0,10	64	167,3	163,04	201308064	16	0,67			
20	54,2	51,14	201308020	8	0,04				65	169,8	165,58	201308065	16	0,69	202308065	20	1,30
21	57,2	53,67	201308021	10	0,04	202308021	10	0,13	66	172,4	168,13						
22	59,4	56,21	201308022	10	0,05	202308022	10	0,14	68	177,5	173,22						
23	62,2	58,75	201308023	10	0,05	202308023	10	0,16	70	182,6	178,31	201308070	16	0,81			
24	64,7	61,29	201308024	10	0,06	202308024	10	0,17	72	187,7	183,41						
25	67,2	63,83	201308025	10	0,06	202308025	10	0,18	75	195,3	191,04	201308075	20	0,93			
26	69,7	66,37	201308026	10	0,07	202308026	12	0,18	76	196,7	193,59	201308076	20	0,94	202308076	20	1,80
27	72,3	68,91	201308027	10	0,07				78	203,0	198,68						
28	74,7	71,45	201308028	10	0,08	202308028	12	0,22	80	208,1	203,77	201308080	20	1,01	202308080	20	2,00
29	77,2	73,99	201308029	10	0,09				85	220,8	216,50	201308085	20	1,20			
30	80,2	76,53	201308030	10	0,09	202308030	12	0,25	90	233,6	229,23	201308090	20	1,35			
31	82,7	79,08	201308031	10	0,10				95	246,3	241,96	201308095	20	1,51			
32	85,2	81,61	201308032	10	0,11	202308032	12	0,29	100	259,1	254,68	201308100	20	1,68			
33	87,7	84,16	201308033	10	0,11				110	284,6	280,15						
34	90,2	86,70	201308034	10	0,12	202308034	12	0,34	114	294,8	290,33	201308114	20	2,20	202308114	20	4,15
35	92,7	89,24	201308035	10	0,13	202308035	12	0,36	120	310,1	305,61	201308120	20	2,44			
36	95,2	91,79	201308036	10	0,13	202308036	12	0,38	125	322,8	318,34	201308125	20	2,65			
37	97,7	94,33	201308037	12	0,14												
38	100,2	96,88	201308038	12	0,15	202308038	12	0,42									
39	102,7	99,42	201308039	12	0,16												
40	105,2	101,97	201308040	12	0,17	202308040	12	0,47									
41	108,4	104,51															
42	111,0	107,05	201308042	12	0,28												
43	113,5	109,60															
44	116,1	112,14	201308044	12	0,31												
45	118,6	114,69	201308045	12	0,32												
46	121,2	117,23	201308046	12	0,34	202308046	16	0,63									
47	123,7	119,77															
48	125,5	122,32	201308048	12	0,37	202308048	16	0,69									
49	128,9	124,86															
50	131,5	127,41	201308050	12	0,40	202308050	16	0,75									



CORONE PER CATENE A RULLI - DIN 8187 - ISO 606

PLATE WHEELS FOR ROLLER CHAINS - DIN 8187 - ISO 606

3/8" x 7/32"
9,525 x 5,72 mm
Rullo 6,35 mm
06B - 1 - 2 - 3

B1	B2	B3	b1	C	r3
5,3	15,4	25,6	5,2	1	10

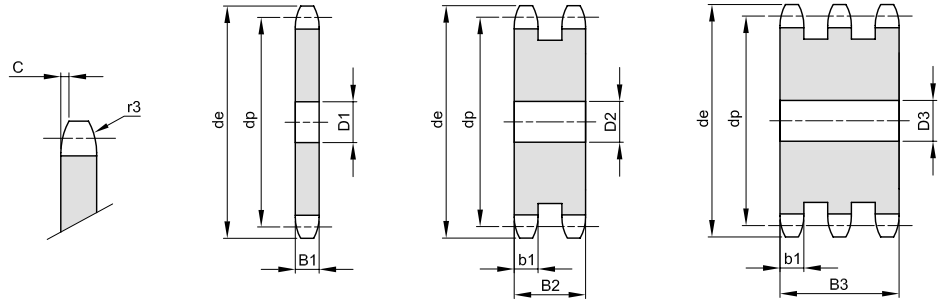

Z	de	dp	semplici			doppi			tripli		
			codice	D1	Kg.	codice	D2	Kg.	codice	D3	Kg.
8	28,6	24,89	201330008	6	0,01	202330008	8	0,03	203330008	8	0,04
9	31,5	27,85	201330009	8	0,02	202330009	8	0,04	203330009	8	0,06
10	34,5	30,82	201330010	8	0,02	202330010	8	0,05	203330010	10	0,08
11	37,5	33,80	201330011	8	0,03	202330011	10	0,06	203330011	12	0,09
12	40,5	36,80	201330012	8	0,03	202330012	10	0,08	203330012	12	0,12
13	43,5	39,80	201330013	8	0,04	202330013	10	0,10	203330013	12	0,15
14	46,5	42,80	201330014	8	0,05	202330014	10	0,12	203330014	12	0,18
15	49,5	45,81	201330015	8	0,06	202330015	10	0,14	203330015	12	0,22
16	52,5	48,82	201330016	10	0,06	202330016	12	0,16	203330016	12	0,26
17	55,5	51,83	201330017	10	0,07	202330017	12	0,19	203330017	12	0,30
18	58,6	54,85	201330018	10	0,08	202330018	12	0,21	203330018	12	0,35
19	61,6	57,87	201330019	10	0,09	202330019	12	0,24	203330019	12	0,39
20	64,6	60,89	201330020	10	0,10	202330020	12	0,27	203330020	12	0,44
21	67,6	63,91	201330021	10	0,12	202330021	12	0,30	203330021	16	0,48
22	70,6	66,93	201330022	10	0,13	202330022	12	0,34	203330022	16	0,54
23	73,7	69,95	201330023	10	0,14	202330023	12	0,37	203330023	16	0,59
24	76,7	72,97	201330024	10	0,15	202330024	12	0,41	203330024	16	0,66
25	79,7	76,00	201330025	10	0,17	202330025	12	0,45	203330025	16	0,72
26	82,7	79,02	201330026	10	0,18	202330026	16	0,48	203330026	16	0,79
27	85,7	82,04	201330027	10	0,20	202330027	16	0,53	203330027	16	0,86
28	88,8	85,07	201330028	10	0,21	202330028	16	0,57	203330028	16	0,93
29	91,8	88,09	201330029	10	0,23	202330029	16	0,62	203330029	16	1,01
30	94,8	91,12	201330030	10	0,25	202330030	16	0,66	203330030	16	1,09
31	97,9	94,15	201330031	12	0,26	202330031	16	0,71	203330031	16	1,17
32	100,9	97,17	201330032	12	0,28	202330032	16	0,77	203330032	16	1,26
33	103,9	100,20	201330033	12	0,30	202330033	16	0,82			
34	106,9	103,23	201330034	12	0,32	202330034	16	0,87	203330034	16	1,44
35	110,0	106,26	201330035	12	0,34	202330035	16	0,93	203330035	16	1,53
36	113,0	109,29	201330036	12	0,36	202330036	16	0,99	203330036	20	1,61
37	116,0	112,32	201330037	12	0,38	202330037	16	1,05			
38	119,0	115,34	201330038	12	0,40	202330038	16	1,11	203330038	20	1,81
39	122,1	118,37	201330039	12	0,43	202330039	16	1,18			
40	125,1	121,40	201330040	12	0,45	202330040	16	1,24	203330040	20	2,02
41	129,0	124,43	201330041	16	0,47	202330041	20	1,30			
42	132,1	127,46	201330042	16	0,49	202330042	20	1,36	203330042	20	2,25
43	135,1	130,49	201330043	16	0,52	202330043	20	1,44			
44	138,1	133,52	201330044	16	0,55	202330044	20	1,51	203330044	20	2,49
45	141,1	136,54	201330045	16	0,57	202330045	20	1,58	203330045	20	2,61
46	144,2	139,58	201330046	16	0,60	202330046	20	1,66			
47	147,2	142,61	201330047	16	0,63						
48	150,2	145,64	201330048	16	0,65	202330048	20	1,82	203330048	20	2,99
49	153,3	148,66	201330049	16	0,68	202330049	20	1,90			
50	156,3	151,69	201330050	20	0,71	202330050	20	1,98	203330050	20	3,27



CORONE PER CATENE A RULLI - DIN 8187 - ISO 606

PLATE WHEELS FOR ROLLER CHAINS - DIN 8187 - ISO 606

3/8" x 7/32"
9,525 x 5,72 mm
Rullo 6,35 mm
06B - 1 - 2 - 3

B1	B2	B3	b1	C	r3
5,3	15,4	25,6	5,2	1	10

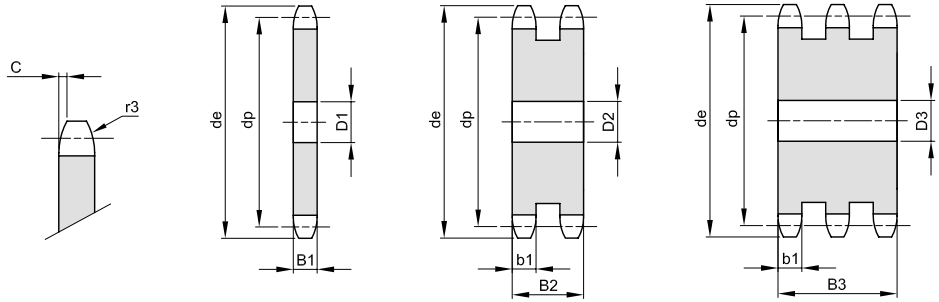

Z	de	dp	semplici			doppi			tripli		
			codice	D1	Kg.	codice	D2	Kg.	codice	D3	Kg.
51	159,3	154,72	201330051	20	0,74	202330051	20	2,06			
52	162,4	157,75	201330052	20	0,77	202330052	20	2,15			
53	165,4	160,78	201330053	20	0,80	202330053	20	2,22			
54	168,4	163,82	201330054	20	0,83	202330054	20	2,33			
55	171,4	166,85	201330055	20	0,86	202330055	20	2,42			
56	174,5	169,88	201330056	20	0,89	202330056	20	2,51			
57	177,5	172,91	201330057	20	0,93	202330057	20	2,61	203330057	25	4,28
58	180,5	175,93	201330058	20	0,96	202330058	20	2,71	203330058	25	4,44
60	186,6	181,99	201330060	20	1,03	202330060	20	2,91	203330060	25	4,77
62	192,7	188,06	201330062	20	1,10	202330062	25	3,09			
64	198,7	194,12	201330064	20	1,18	202330064	25	3,30	203330064	25	5,46
65	201,8	197,15	201330065	20	1,21	202330065	25	3,41	203330065	25	5,64
66	204,8	200,18	201330066	20	1,25				203330066	25	5,83
68	210,8	206,24	201330068	20	1,33	202330068	25	3,75			
70	216,9	212,30	201330070	20	1,41	202330070	25	3,99	203330070	25	6,59
72	223,0	218,37	201330072	20	1,50	202330072	25	4,23	203330072	25	6,99
75	232,1	227,46	201330075	20	1,63	202330075	25	4,60			
76	235,1	230,49	201330076	20	1,67	202330076	25	4,73	203330076	25	7,83
78	241,2	236,55				202330078	25	4,99			
80	247,2	242,61	201330080	20	1,86	202330080	25	5,26	203330080	25	8,71
85	262,4	257,77	201330085	25	2,10	202330085	25	5,96	203330085	25	9,87
90	277,5	272,93	201330090	25	2,36	202330090	25	6,71	203330090	25	11,11
95	292,7	288,08	201330095	25	2,63	202330095	25	7,50	203330095	25	12,42
100	307,8	303,25	201330100	25	2,92	202330100	25	8,34	203330100	25	13,81
110	338,2	333,55	201330110	25	3,54	202330110	25	10,14			
114	350,3	345,68	201330114	25	3,81	202330114	25	10,90	203330114	25	18,06
120	368,5	363,86	201330120	25	4,23	202330120	25	12,11			
125	383,6	379,02	201330125	25	4,59	202330125	25	13,16	203330125	25	21,81



CORONE PER CATENE A RULLI - DIN 8187 - ISO 606

PLATE WHEELS FOR ROLLER CHAINS - DIN 8187 - ISO 606

1/2" x 1/8"
12,7 x 3,3 mm
Rullo 7,75 mm
081 - 1

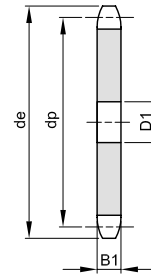
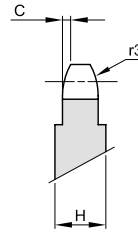
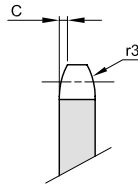

Da Z 31 H=4 mm
 Da Z 90 H=6 mm

B1	B2	B3	b1	C	r3
3				0,8	13

Z	de	dp	semplici			doppi			Z	de	dp	semplici			doppi		
			codice	D1	Kg.	codice	D2	Kg.				codice	D1	Kg.	codice	D2	Kg.
8	39,5	33,18							51	213,1	206,30						
9	43,4	37,13	201341009	8	0,02				52	217,1	210,34						
10	47,4	41,10	201341010	8	0,02				53	221,2	214,87						
11	51,4	45,07	201341011	8	0,03				54	225,2	218,43						
12	55,4	49,07	201341012	8	0,04				55	229,3	222,46	201341055	20	1,25			
13	59,4	53,06	201341013	8	0,04				56	233,3	226,50	201341056	20	1,30			
14	63,4	57,07	201341014	8	0,05				57	237,3	230,54	201341057	20	1,35			
15	67,4	61,09	201341015	8	0,06				58	241,4	234,58						
16	71,4	65,10	201341016	8	0,07				59	245,4	238,62						
17	75,4	69,11	201341017	8	0,08				60	249,5	242,66	201341060	20	1,50			
18	79,4	73,14	201341018	8	0,09				62	257,5	250,75						
19	83,5	77,16	201341019	8	0,10				64	265,6	258,82						
20	87,5	81,19	201341020	8	0,11				65	269,7	262,86						
21	91,5	85,22	201341021	8	0,11				66	273,7	266,90						
22	95,5	89,24	201341022	10	0,13				68	281,8	274,99						
23	99,6	93,27	201341023	10	0,15				70	289,9	283,07	201341070	25	2,05			
24	103,6	97,29	201341024	12	0,16				72	298,0	291,16						
25	107,6	101,33	201341025	12	0,17				75	310,1	303,27						
26	111,7	105,36	201341026	12	0,26				76	314,1	307,33						
27	115,7	109,40	201341027	12	0,28				78	322,2	315,40						
28	119,7	113,42	201341028	12	0,32				80	330,3	323,48						
29	123,8	117,46							85	350,5	343,69						
30	127,8	121,50	201341030	12	0,35				90	370,7	363,90						
31	131,8	125,54							95	390,9	384,11						
32	135,9	129,56	201341032	12	0,40				100	411,1	404,31						
33	139,9	133,60	201341033	12	0,43				110	451,5	444,74						
34	143,9	137,64	201341034	12	0,46				114	467,7	460,90						
35	148,0	141,68	201341035	12	0,49				120	492,0	485,16						
36	152,0	145,72	201341036	16	0,51				125	512,2	505,37						
37	156,1	149,76	201341037	16	0,55												
38	160,1	153,80	201341038	16	0,58												
39	164,1	157,83	201341039	16	0,61												
40	168,2	161,87	201341040	16	0,64												
41	172,7	165,91															
42	176,7	169,95															
43	180,8	173,99															
44	184,8	178,03	201341044	16	0,79												
45	188,9	182,07	201341045	16	0,82												
46	192,9	186,10															
47	196,9	190,14															
48	201,0	194,18	201341048	20	0,94												
49	205,0	198,22															
50	209,1	202,26															



CORONE PER CATENE A RULLI - DIN 8187 - ISO 606

PLATE WHEELS FOR ROLLER CHAINS - DIN 8187 - ISO 606

1/2" x 3/16"
12,7 x 4,88 mm
 Rullo 7,75 mm
083 - 1 / 084 - 1

B1	B2	B3	b1	C	r3
4,5				1,3	13

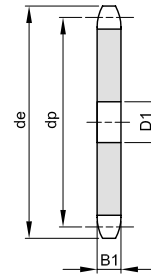
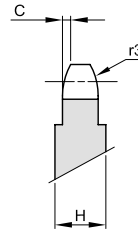
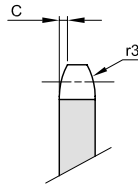

Da Z 90 H=6 mm

Z	de	dp	semplici			doppi			Z	de	dp	semplici			doppi		
			codice	D1	Kg.	codice	D2	Kg.				codice	D1	Kg.	codice	D2	Kg.
8	39,5	33,18	201342008	8	0,02				51	213,1	206,30	201342051	20	1,12			
9	43,4	37,13	201342009	8	0,03				52	217,1	210,34	201342052	20	1,17			
10	47,4	41,10	201342010	8	0,04				53	221,2	214,37	201342053	20	1,22			
11	51,4	45,07	201342011	8	0,05				54	225,2	218,43	201342054	20	1,26			
12	55,4	49,07	201342012	8	0,05				55	229,3	222,46	201342055	20	1,31			
13	59,4	53,06	201342013	8	0,06				56	233,3	226,50	201342056	20	1,36			
14	63,4	57,07	201342014	8	0,08				57	237,3	230,54	201342057	20	1,41			
15	67,4	61,09	201342015	8	0,09				58	241,4	234,58	201342058	20	1,46			
16	71,4	65,10	201342016	8	0,10				59	245,5	238,62						
17	75,4	69,11	201342017	8	0,12				60	249,5	242,66	201342060	20	1,57			
18	79,4	73,14	201342018	8	0,13				62	257,5	250,75						
19	83,5	77,16	201342019	8	0,15				64	265,6	258,82	201342064	20	1,80			
20	87,5	81,19	201342020	8	0,16				65	269,7	262,86	201342065	20	1,85			
21	91,5	85,22	201342021	8	0,18				66	273,7	266,90						
22	95,5	89,24	201342022	10	0,20				68	281,8	274,99	201342068	25	2,02			
23	99,6	93,27	201342023	10	0,22				70	289,9	283,07	201342070	25	2,14			
24	103,6	97,29	201342024	12	0,24				72	298,0	291,16	201342072	25	2,27			
25	107,6	101,33	201342025	12	0,26				75	310,1	303,27						
26	111,7	105,36	201342026	12	0,28				76	314,1	307,33	201342076	25	2,54			
27	115,7	109,40	201342027	12	0,30				78	322,2	315,40						
28	119,7	113,42	201342028	12	0,33				80	330,3	323,48	201342080	25	2,82			
29	123,8	117,46	201342029	12	0,35				85	350,5	343,69	201342085	25	3,19			
30	127,8	121,50	201342030	12	0,38				90	370,7	363,90						
31	131,8	125,54	201342031	12	0,40				95	390,9	384,11						
32	135,9	129,56	201342032	12	0,43				100	411,1	404,31	201342100	25	5,83			
33	139,9	133,60	201342033	12	0,46				110	451,5	444,74						
34	143,9	137,64	201342034	12	0,49				114	467,7	460,90						
35	148,0	141,68	201342035	12	0,52				120	492,0	485,16						
36	152,0	145,72	201342036	16	0,55				125	512,2	505,37						
37	156,1	149,76	201342037	16	0,58												
38	160,1	153,80	201342038	16	0,62												
39	164,1	157,83	201342039	16	0,65												
40	168,2	161,87	201342040	16	0,68												
41	172,7	165,91	201342041	16	0,72												
42	176,7	169,95	201342042	16	0,76												
43	180,8	173,99	201342043	16	0,80												
44	184,8	178,03	201342044	16	0,83												
45	188,9	182,07	201342045	16	0,87												
46	192,9	186,10	201342046	20	0,91												
47	196,9	190,14	201342047	20	0,95												
48	201,0	194,18	201342048	20	0,99												
49	205,0	198,22	201342049	20	1,04												
50	209,1	202,26	201342050	20	1,08												



CORONE PER CATENE A RULLI - DIN 8187 - ISO 606

PLATE WHEELS FOR ROLLER CHAINS - DIN 8187 - ISO 606

1/2" x 5/16"
12,7 x 7,75 mm
 Rullo 8,51 mm
08B - 1 - 2 - 3

B1	B2	B3	b1	C	r3
7,2	21	34,9	7	1,3	13

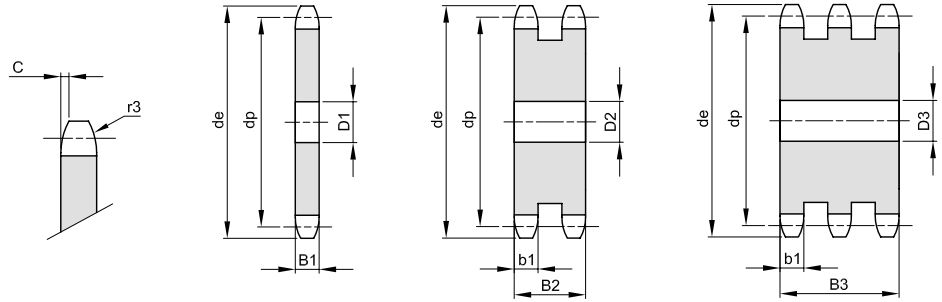

Z	de	dp	semplici			doppi			tripli		
			codice	D1	Kg.	codice	D2	Kg.	codice	D3	Kg.
8	38,0	33,18	201340008	8	0,03	202340008	10	0,07	203340008	10	0,11
9	42,0	37,13	201340009	8	0,04	202340009	10	0,10	203340009	10	0,16
10	45,9	41,10	201340010	8	0,06	202340010	10	0,13	203340010	10	0,21
11	49,9	45,07	201340011	10	0,07	202340011	10	0,17	203340011	12	0,26
12	53,9	49,07	201340012	10	0,08	202340012	10	0,21	203340012	12	0,33
13	57,9	53,06	201340013	10	0,10	202340013	10	0,25	203340013	12	0,40
14	61,9	57,07	201340014	10	0,12	202340014	10	0,30	203340014	12	0,48
15	65,9	61,09	201340015	10	0,14	202340015	10	0,36	203340015	12	0,57
16	69,9	65,10	201340016	10	0,16	202340016	12	0,41	203340016	16	0,64
17	74,0	69,11	201340017	10	0,18	202340017	12	0,47	203340017	16	0,74
18	78,0	73,14	201340018	10	0,20	202340018	12	0,54	203340018	16	0,85
19	82,0	77,16	201340019	10	0,23	202340019	12	0,61	203340019	16	0,97
20	86,0	81,19	201340020	10	0,26	202340020	12	0,68	203340020	16	1,09
21	90,1	85,22	201340021	12	0,28	202340021	16	0,75	203340021	16	1,22
22	94,1	89,24	201340022	12	0,31	202340022	16	0,83	203340022	16	1,36
23	98,1	93,27	201340023	12	0,34	202340023	16	0,92	203340023	16	1,50
24	102,1	97,29	201340024	12	0,38	202340024	16	1,01	203340024	16	1,63
25	106,2	101,33	201340025	12	0,41	202340025	16	1,10	203340025	16	1,81
26	110,2	105,36	201340026	16	0,44	202340026	16	1,20	203340026	16	1,98
27	114,2	109,40	201340027	16	0,48	202340027	16	1,31	203340027	16	2,15
28	118,3	113,42	201340028	16	0,52	202340028	16	1,42	203340028	16	2,33
29	122,3	117,46	201340029	16	0,56	202340029	16	1,53	203340029	16	2,52
30	126,3	121,50	201340030	16	0,60	202340030	16	1,65	203340030	16	2,71
31	130,4	125,54	201340031	16	0,64	202340031	16	1,77			
32	134,4	129,56	201340032	16	0,68	202340032	16	1,90	203340032	20	3,09
33	138,4	133,60	201340033	16	0,73	202340033	16	2,02	203340033	20	3,30
34	142,5	137,64	201340034	16	0,78	202340034	16	2,16	203340034	20	3,53
35	146,5	141,68	201340035	16	0,83	202340035	16	2,30	203340035	20	3,76
36	150,6	145,72	201340036	16	0,88	202340036	20	2,42	203340036	20	3,99
37	154,6	149,76	201340037	16	0,93	202340037	20	2,56			
38	158,6	153,80	201340038	16	0,98	202340038	20	2,71	203340038	20	4,49
39	162,7	157,83	201340039	16	1,03	202340039	20	2,87			
40	166,7	161,87	201340040	16	1,09	202340040	20	3,03	203340040	20	5,00
41	172,4	165,91	201340041	20	1,14	202340041	20	3,20			
42	176,5	169,95	201340042	20	1,20	202340042	20	3,36	203340042	25	5,51
43	180,5	173,99	201340043	20	1,26	202340043	20	3,53	203340043	25	5,80
44	184,6	178,03	201340044	20	1,32	202340044	20	3,71	203340044	25	6,09
45	188,6	182,07	201340045	20	1,38	202340045	20	3,89	203340045	25	6,39
46	192,6	186,10	201340046	20	1,45	202340046	20	4,07	203340046	25	6,70
47	196,7	190,14	201340047	20	1,51				203340047	25	7,00
48	200,7	194,18	201340048	20	1,58	202340048	20	4,96	203340048	25	7,33
49	204,8	198,22	201340049	20	1,65	202340049	20	4,66			
50	208,8	202,26	201340050	20	1,72	202340050	20	4,86	203340050	25	8,00



CORONE PER CATENE A RULLI - DIN 8187 - ISO 606

PLATE WHEELS FOR ROLLER CHAINS - DIN 8187 - ISO 606

1/2" x 5/16"
12,7 x 7,75 mm
Rullo 8,51 mm
08B - 1 - 2 - 3

B1	B2	B3	b1	C	r3
7,2	21	34,9	7	1,3	13

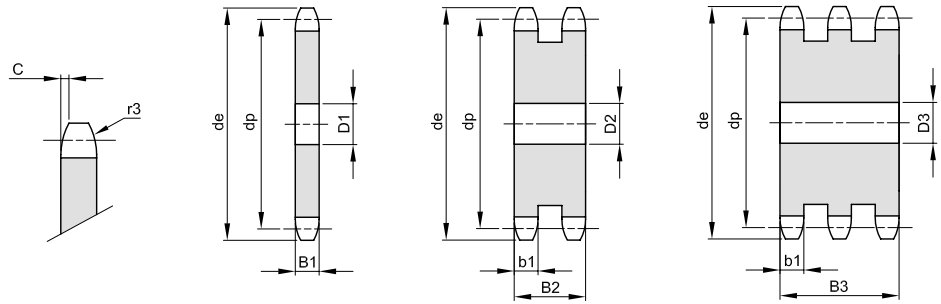

Z	de	dp	semplici			doppi			tripli		
			codice	D1	Kg.	codice	D2	Kg.	codice	D3	Kg.
51	212,8	206,30	201340051	20	1,80	202340051	25	5,03			
52	216,9	210,34	201340052	20	1,87	202340052	25	5,24	203340052	25	8,68
53	220,9	214,37	201340053	20	1,94	202340053	25	5,46			
54	225,0	218,43	201340054	20	2,02	202340054	25	5,68	203340054	25	9,40
55	229,0	222,46	201340055	20	2,10	202340055	25	5,90	203340055	25	9,77
56	233,0	226,50	201340056	20	2,17	202340056	25	6,13	203340056	25	10,15
57	237,1	230,54	201340057	20	2,25	202340057	25	6,36	203340057	25	10,53
58	241,1	234,58	201340058	20	2,34	202340058	25	6,59			
59	245,2	238,62									
60	249,2	242,66	201340060	20	2,50	202340060	25	7,08	203340060	25	11,73
62	257,3	250,75	201340062	25	2,67	202340062	25	7,60	203340062	25	15,56
64	265,4	258,82	201340064	25	2,70	202340064	25	8,10			
65	269,4	262,86	201340065	25	2,78	202340065	25	8,36	203340065	25	13,86
66	273,4	266,90	201340066	25	2,94						
68	281,5	274,99	201340068	25	3,00	202340068	25	9,20	203340068	25	15,22
70	289,6	283,07	201340070	25	3,22	202340070	25	9,75	203340070	25	16,17
72	297,7	291,16	201340072	25	3,50	202340072	25	10,33	203340072	25	17,14
75	309,8	303,27	201340075	25	3,80	202340075	25	11,24	203340075	25	18,65
76	313,9	307,33	201340076	25	3,90	202340076	25	11,55	203340076	25	19,17
78	321,9	315,40	201340078	25	3,90						
80	330,0	323,48	201340080	25	4,26	202340080	25	12,90	203340080	25	21,82
85	350,2	343,69	201340085	25	4,76	202340085	25	14,55	203340085	25	24,15
90	370,4	363,90	201340090	25	5,52	202340090	25	16,36	203340090	25	27,17
95	390,7	384,11	201340095	25	6,12	202340095	25	18,28	203340095	25	30,36
100	410,9	404,31	201340100	25	6,70	202340100	25	20,30	203340100	25	33,73
110	451,3	444,74	201340110	25	7,88	202340110	25	24,67			
114	467,4	460,90	201340114	25	8,31	202340114	25	26,53	203340114	25	44,10
120	491,7	485,16	201340120	25	9,60	202340120	25	29,46			
125	511,0	505,37	201340125	25	10,00	202340125	25	32,00	203340125	25	55,21



CORONE PER CATENE A RULLI - DIN 8187 - ISO 606

PLATE WHEELS FOR ROLLER CHAINS - DIN 8187 - ISO 606

5/8" x 3/8"
15,875 x 9,65 mm
 Rullo 10,16 mm
10B - 1 - 2 - 3

B1	B2	B3	b1	C	r3
9,1	25,5	42,1	9	1,6	16

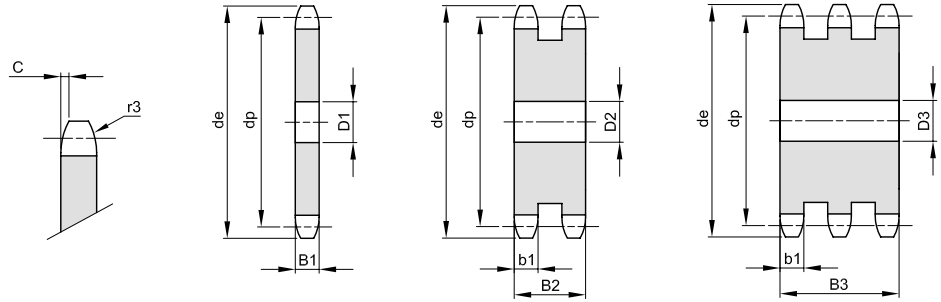

Z	de	dp	semplici			doppi			tripli		
			codice	D1	Kg.	codice	D2	Kg.	codice	D3	Kg.
8	48,4	41,48	201350008	10	0,06	202350008	10	0,15	203350008	12	0,23
9	53,3	46,42	201350009	10	0,09	202350009	10	0,21	203350009	12	0,32
10	58,3	51,37	201350010	10	0,11	202350010	10	0,27	203350010	12	0,44
11	63,2	56,34	201350011	10	0,14	202350011	10	0,34	203350011	12	0,55
12	68,2	61,34	201350012	10	0,17	202350012	10	0,42	203350012	12	0,67
13	73,2	66,32	201350013	10	0,20	202350013	10	0,51	203350013	12	0,81
14	78,2	71,34	201350014	12	0,23	202350014	10	0,60	203350014	12	0,97
15	83,2	76,36	201350015	12	0,27	202350015	12	0,70	203350015	12	1,14
16	88,3	81,37	201350016	12	0,31	202350016	12	0,82	203350016	16	1,29
17	93,3	86,39	201350017	12	0,36	202350017	12	0,94	203350017	16	1,49
18	98,3	91,42	201350018	12	0,41	202350018	12	1,06	203350018	16	1,70
19	103,3	96,45	201350019	12	0,46	202350019	12	1,20	203350019	16	1,92
20	108,4	101,49	201350020	12	0,51	202350020	12	1,34	203350020	16	2,15
21	113,4	106,52	201350021	12	0,57	202350021	16	1,48	203350021	16	2,40
22	118,4	111,55	201350022	12	0,62	202350022	16	1,64	203350022	16	2,66
23	123,5	116,58	201350023	12	0,69	202350023	16	1,80	203350023	16	2,94
24	128,5	121,62	201350024	12	0,75	202350024	16	1,98	203350024	16	3,23
25	133,6	126,66	201350025	12	0,82	202350025	16	2,17	203350025	16	3,53
26	138,6	131,70	201350026	16	0,88	202350026	20	2,33	203350026	20	3,81
27	143,6	136,75	201350027	16	0,95	202350027	20	2,53	203350027	20	4,13
28	148,7	141,78	201350028	16	1,03	202350028	20	2,74	203350028	20	4,47
29	153,7	146,83	201350029	16	1,11	202350029	20	2,96	203350029	20	4,83
30	158,8	151,87	201350030	16	1,19	202350030	20	3,18	203350030	20	5,20
31	163,8	156,92	201350031	16	1,28	202350031	20	3,41			
32	168,9	161,95	201350032	16	1,36	202350032	20	3,66	203350032	20	5,97
33	173,9	167,00	201350033	16	1,45	202350033	20	3,90	203350033	20	6,38
34	178,9	172,05	201350034	16	1,55	202350034	20	4,16	203350034	20	6,80
35	184,0	177,10	201350035	16	1,64	202350035	20	4,42	203350035	20	7,23
36	189,0	182,15	201350036	20	1,73	202350036	20	4,70	203350036	25	7,62
37	194,1	187,20	201350037	20	1,83	202350037	20	4,98	203350037	25	8,08
38	199,1	192,24	201350038	20	1,94	202350038	20	5,26	203350038	25	8,55
39	204,2	197,29	201350039	20	2,05	202350039	20	5,56	203350039	25	9,04
40	209,2	202,34	201350040	20	2,16	202350040	20	5,87	203350040	25	9,54
41	215,8	207,39	201350041	20	2,29				203350041	25	10,05
42	220,8	212,44	201350042	20	2,39	202350042	25	6,46	203350042	25	10,58
43	225,9	217,49	201350043	20	2,50	202350043	25	6,80			
44	230,9	222,53	201350044	20	2,63	202350044	25	7,13	203350044	25	11,67
45	236,0	227,58	201350045	20	2,75	202350045	25	7,47	203350045	25	12,24
46	241,0	236,63	201350046	20	2,88	202350046	25	7,83	203350046	25	12,82
47	246,1	237,68	201350047	20	3,01	202350047	25	8,19			
48	251,1	242,73	201350048	20	3,14	202350048	25	8,55	203350048	25	14,01
49	256,2	247,78	201350049	20	3,28						
50	261,2	252,82	201350050	20	3,42	202350050	25	9,32	203350050	25	15,26



CORONE PER CATENE A RULLI - DIN 8187 - ISO 606

PLATE WHEELS FOR ROLLER CHAINS - DIN 8187 - ISO 606

5/8" x 3/8"
15,875 x 9,65 mm
 Rullo 10,16 mm
10B - 1 - 2 - 3

B1	B2	B3	b1	C	r3
9,1	25,5	42,1	9	1,6	16

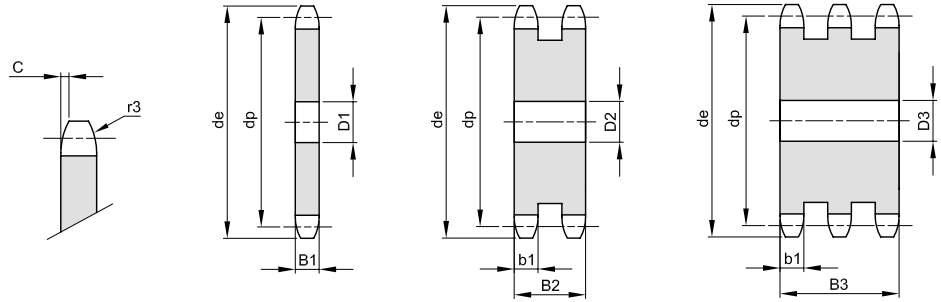

Z	de	dp	semplici			doppi			tripli		
			codice	D1	Kg.	codice	D2	Kg.	codice	D3	Kg.
51	266,3	257,87	201350051	20	3,56						
52	271,3	262,92	201350052	20	3,70	202350052	25	10,11	203350052	25	16,57
53	276,4	267,97	201350053	20	3,85	202350053	25	10,52			
54	281,4	273,03	201350054	20	4,00	202350054	25	10,94			
55	286,5	278,08	201350055	20	4,15	202350055	25	11,36	203350055	25	18,62
56	291,5	283,13	201350056	25	4,30	202350056	25	11,80			
57	296,6	288,18	201350057	25	4,46	202350057	25	12,24	203350057	25	20,06
58	301,6	293,23	201350058	25	4,62	202350058	25	12,68			
60	311,7	303,32	201350060	25	4,95	202350060	25	13,61	203350060	25	22,31
62	321,8	313,43	201350062	25	5,30	202350062	25	14,56			
64	331,9	323,53	201350064	25	5,65				203350064	30	25,43
65	337,0	328,58	201350065	25	5,83	202350065	25	16,05	203350065	30	26,26
66	342,0	333,63				202350066	25	16,57			
68	352,1	343,74	201350068	25	6,40						
70	362,2	353,84	201350070	25	6,79	202350070	25	18,70	203350070	30	30,61
72	372,3	363,95	201350072	25	6,80	202350072	25	19,81			
75	387,5	379,09	201350075	25	7,81	202350075	25	21,54	203350075	30	30,35
76	392,5	384,16	201350076	25	8,02	202350076	25	22,14	203350076	30	36,27
78	402,6	394,25	201350078	25	8,46						
80	412,7	404,35	201350080	25	8,91	202350080	25	24,60	203350080	30	40,30
85	438,0	429,62	201350085	30	10,06	202350085	30	28,00			
90	463,3	454,88	201350090	30	11,30	202350090	30	31,25	203350090	30	51,32
95	488,5	480,14	201350095	30	12,61	202350095	30	34,90	203350095	30	57,32
100	513,8	505,40	201350100	30	13,99	202350100	30	38,75			
110	564,3	555,92	201350110	30	15,50						
114	584,5	576,13	201350114	30	17,50	202350114	30	50,60	203350114	30	83,15
120	614,8	606,44	201350120	30	17,60	202350120	30	56,16			
125	640,1	631,71	201350125	30	21,00	202350125	30	61,00	203350125	30	100,29



CORONE PER CATENE A RULLI - DIN 8187 - ISO 606

PLATE WHEELS FOR ROLLER CHAINS - DIN 8187 - ISO 606

3/4" x 7/16"
19,05 x 11,68 mm
 Rullo 12,07 mm
12B - 1 - 2 - 3

B1	B2	B3	b1	C	r3
11,1	30,3	49,8	10,8	2	19

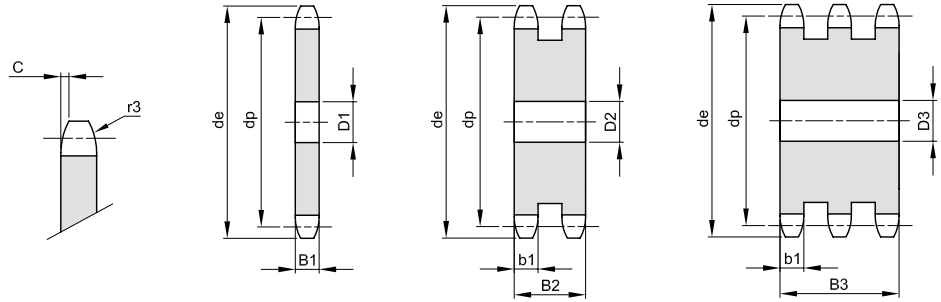

Z	de	dp	semplici			doppi			tripli		
			codice	D1	Kg.	codice	D2	Kg.	codice	D3	Kg.
8	58,0	49,78	201360008	10	0,12	202360008	12	0,26	203360008	12	0,31
9	63,9	55,70	201360009	10	0,15	202360009	12	0,36	203360009	12	0,57
10	69,8	61,64	201360010	10	0,20	202360010	12	0,46	203360010	12	0,74
11	75,8	67,61	201360011	12	0,24	202360011	12	0,59	203360011	16	0,91
12	81,8	73,50	201360012	14	0,30	202360012	14	0,72	203360012	16	1,13
13	87,8	79,59	201360013	14	0,35	202360013	14	0,88	203360013	16	1,38
14	93,8	85,61	201360014	14	0,41	202360014	16	1,02	203360014	16	1,64
15	99,8	91,63	201360015	14	0,48	202360015	16	1,20	203360015	16	1,93
16	105,8	97,65	201360016	14	0,55	202360016	16	1,39	203360016	20	2,20
17	111,9	103,67	201360017	14	0,63	202360017	16	1,60	203360017	20	2,54
18	117,9	109,71	201360018	14	0,71	202360018	16	1,81	203360018	20	2,89
19	123,9	115,75	201360019	14	0,80	202360019	16	2,05	203360019	20	3,27
20	130,0	121,78	201360020	14	0,89	202360020	16	2,30	203360020	20	3,67
21	136,0	127,82	201360021	16	0,99	202360021	20	2,53	203360021	20	4,10
22	142,0	133,86	201360022	16	1,03	202360022	20	2,80	203360022	20	4,55
23	148,1	139,90	201360023	16	1,20	202360023	20	3,09	203360023	20	5,02
24	154,1	145,94	201360024	16	1,31	202360024	20	3,39	203360024	20	5,51
25	160,2	152,00	201360025	16	1,43	202360025	20	3,70	203360025	20	6,02
26	166,2	158,04	201360026	16	1,56	202360026	20	4,03	203360026	20	6,56
27	172,3	164,09	201360027	16	1,68	202360027	20	4,38	203360027	20	7,12
28	178,3	170,13	201360028	16	1,82	202360028	20	4,73	203360028	20	7,71
29	184,4	176,19	201360029	16	1,96	202360029	20	5,10	203360029	20	8,31
30	190,4	182,25	201360030	16	2,10	202360030	20	5,49	203360030	20	8,97
31	196,5	188,31	201360031	20	2,24	202360031	20	5,88	203360031	25	9,52
32	202,5	194,35	201360032	20	2,39	202360032	20	6,30	203360032	25	10,19
33	208,6	200,40	201360033	20	2,55	202360033	20	6,72	203360033	25	10,89
34	214,6	206,46	201360034	20	2,71	202360034	20	7,16	203360034	25	11,61
35	220,7	212,52	201360035	20	2,88	202360035	20	7,61	203360035	25	12,35
36	226,8	218,58	201360036	20	3,06	202360036	25	7,99	203360036	25	13,11
37	232,8	224,64	201360037	20	3,24	202360037	25	8,47	203360037	25	13,90
38	238,9	230,69	201360038	20	3,42	202360038	25	8,96	203360038	25	14,70
39	244,9	236,75	201360039	20	3,61	202360039	25	9,50	203360039	25	15,54
40	251,0	242,81	201360040	20	3,80	202360040	25	9,99	203360040	25	16,40
41	258,9	248,87	201360041	25	3,98	202360041	25	10,51			
42	265,0	254,93	201360042	25	4,19	202360042	25	11,07	203360042	25	18,17
43	271,1	260,98	201360043	25	4,38	202360043	25	11,63	203360043	25	19,09
44	277,1	267,03	201360044	25	4,61	202360044	25	12,21	203360044	25	20,03
45	283,2	273,10	201360045	25	4,83	202360045	25	12,80	203360045	25	21,00
46	289,2	279,16	201360046	25	5,05	202360046	25	13,40			
47	295,3	285,21	201360047	25	5,28	202360047	25	14,02	203360047	25	23,00
48	301,4	291,27	201360048	25	5,52	202360048	25	14,65	203360048	25	24,04
49	307,4	297,33	201360049	25	5,76						
50	313,5	303,39	201360050	25	6,00	202360050	25	15,95	203360050	25	26,17



CORONE PER CATENE A RULLI - DIN 8187 - ISO 606

PLATE WHEELS FOR ROLLER CHAINS - DIN 8187 - ISO 606

3/4" x 7/16"
19,05 x 11,68 mm
 Rullo 12,07 mm
12B - 1 - 2 - 3

B1	B2	B3	b1	C	r3
11,1	30,3	49,8	10,8	2	19

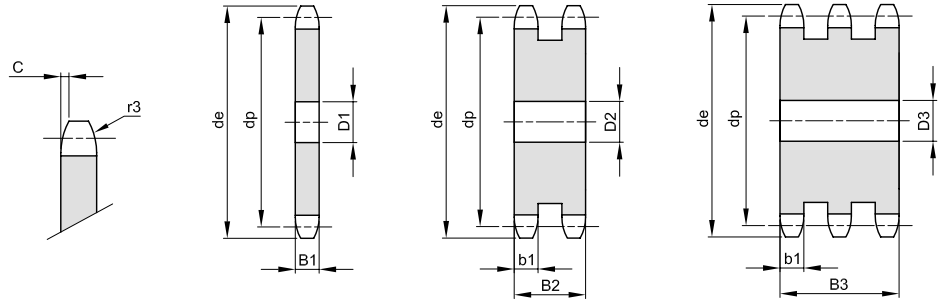

Z	de	dp	semplici			doppi			tripli		
			codice	D1	Kg.	codice	D2	Kg.	codice	D3	Kg.
51	319,5	309,45	201360051	25	6,25						
52	325,6	315,50	201360052	25	6,50	202360052	25	17,31	203360052	25	28,40
53	331,6	321,56	201360053	25	6,77						
54	337,7	327,64	201360054	25	7,03	202360054	25	18,73	203360054	25	30,72
55	343,8	333,70	201360055	25	7,30	202360055	25	19,45	203360055	25	31,91
56	349,8	339,75	201360056	25	7,57	202360056	25	20,20			
57	355,9	345,81	201360057	25	7,85	202360057	25	20,95	203360057	30	34,28
58	362,0	351,87	201360058	25	8,13	202360058	25	21,72			
60	374,1	363,99	201360060	25	8,72	202360060	25	23,30	203360060	30	38,12
62	386,2	376,12	201360062	25	9,33						
64	398,3	388,24	201360064	25	9,95	202360064	30	26,62			
65	404,4	394,29	201360065	25	10,27	202360065	30	27,48	203360065	30	45,00
68	422,6	412,49	201360068	30	11,24	202360068	30	29,00			
70	434,7	424,61	201360070	30	11,92	202360070	30	32,01	203360070	30	52,42
72	446,8	436,74	201360072	30	12,63	202360072	30	33,92	203360072	30	55,55
75	465,0	454,91	201360075	30	13,72	202360075	30	36,88			
76	471,1	460,99	201360076	30	14,09	202360076	30	37,90	203360076	30	62,09
78	483,2	473,10	201360078	30	14,86						
80	495,3	485,22	201360080	30	15,65	202360080	30	42,10	203360080	30	68,98
85	525,6	515,55	201360085	30	17,70	202360085	30	47,66	203360085	30	78,10
90	555,9	545,86	201360090	30	19,87	202360090	30	53,36	203360090	30	87,79
95	586,2	576,17	201360095	30	20,10	202360095	30	59,80	203360095	30	98,04
100	616,6	606,47	201360100	30	24,60	202360100	30	66,39	203360100	30	108,86
110	677,2	667,11	201360110	30	29,84						
114	701,4	691,36	201360114	30	32,07	202360114	30	86,68	203360114	30	142,15
120	737,8	727,74	201360120	30	35,58				203360120	30	157,77
125	768,1	758,05	201360125	30	38,63	202360125	30	104,50	203360125	30	171,41



CORONE PER CATENE A RULLI - DIN 8187 - ISO 606

PLATE WHEELS FOR ROLLER CHAINS - DIN 8187 - ISO 606

1" x 17,02 mm
25,4 x 17,02 mm
Rullo 15,88 mm
16B - 1 - 2 - 3

B1	B2	B3	b1	C	r3
16,2	47,7	79,6	15,8	2,5	26

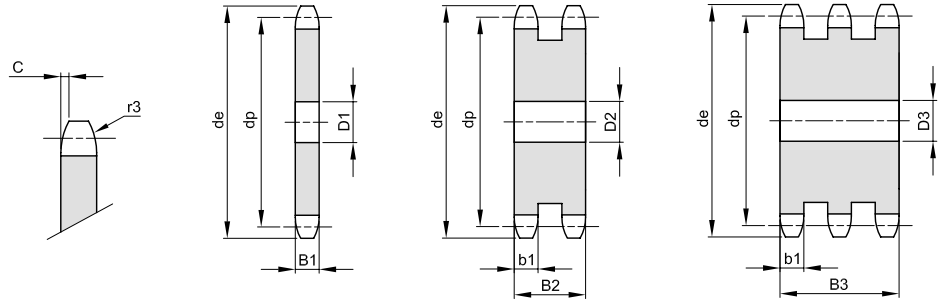

Z	de	dp	semplici			doppi			tripli		
			codice	D1	Kg.	codice	D2	Kg.	codice	D3	Kg.
8	77,9	66,37	201380008	16	0,30	202380008	16	0,71	203380008	16	1,13
9	85,8	74,27	201380009	16	0,39	202380009	16	0,97	203380009	16	1,56
10	93,8	82,19	201380010	16	0,51	202380010	16	1,27	203380010	16	2,05
11	101,7	90,14	201380011	16	0,63	202380011	20	1,57	203380011	20	2,53
12	109,7	98,14	201380012	16	0,77	202380012	20	1,94	203380012	20	3,15
13	117,7	106,12	201380013	16	0,92	202380013	20	2,36	203380013	20	3,84
14	125,7	114,15	201380014	16	1,08	202380014	20	2,81	203380014	20	4,59
15	133,7	122,17	201380015	16	1,26	202380015	20	3,31	203380015	20	5,40
16	141,8	130,20	201380016	20	1,43	202380016	20	3,84	203380016	25	6,16
17	149,8	138,22	201380017	20	1,50	202380017	20	4,41	203380017	25	7,11
18	157,8	146,28	201380018	20	1,85	202380018	20	5,01	203380018	25	8,11
19	165,9	154,33	201380019	20	2,08	202380019	20	5,66	203380019	25	9,18
20	173,9	162,38	201380020	20	2,32	202380020	20	6,34	203380020	25	10,31
21	182,0	170,43	201380021	20	2,58	202380021	25	7,00	203380021	25	11,51
22	190,1	178,48	201380022	20	2,84	202380022	25	7,76	203380022	25	12,77
23	198,1	186,53	201380023	20	3,13	202380023	25	8,56	203380023	25	14,10
24	206,2	194,59	201380024	20	3,42	202380024	25	9,40	203380024	25	14,49
25	214,2	202,66	201380025	20	3,73	202380025	25	10,28	203380025	25	16,94
26	222,3	210,72	201380026	20	4,05	202380026	25	11,20	203380026	30	18,33
27	230,4	218,79	201380027	20	4,38	202380027	25	12,15	203380027	30	19,91
28	238,4	226,85	201380028	20	4,73	202380028	25	13,14	203380028	30	21,55
29	246,5	234,92	201380029	20	5,09	202380029	25	14,17	203380029	30	23,26
30	254,6	243,00	201380030	20	5,46	202380030	25	15,24	203380030	30	25,04
31	262,6	251,08	201380031	25	5,82	202380031	25	16,35	203380031	30	26,88
32	270,7	259,13	201380032	25	6,22	202380032	25	17,50	203380032	30	28,78
33	278,8	267,21	201380033	25	6,63	202380033	25	18,68	203380033	30	30,75
34	286,9	275,28	201380034	25	7,06	202380034	25	19,90	203380034	30	32,78
35	294,9	283,36	201380035	25	7,50	202380035	25	21,16	203380035	30	34,88
36	303,0	291,44	201380036	25	7,95	202380036	25	22,46	203380036	30	37,04
37	311,1	299,51	201380037	25	8,41	202380037	25	23,80			
38	319,2	307,59	201380038	25	8,88	202380038	25	25,18	203380038	30	41,56
39	327,2	315,67	201380039	25	9,37	202380039	25	26,59			
40	335,3	323,73	201380040	25	9,88	202380040	25	28,04	203380040	30	46,42
41	345,6	331,82	201380041	25	10,39						
42	353,7	339,90	201380042	25	10,92	202380042	25	31,07	203380042	30	51,34
43	361,7	347,98	201380043	25	11,46						
44	369,8	356,06	201380044	25	12,02	202380044	25	34,24	203380044	30	56,63
45	377,9	364,12	201380045	25	12,60	202380045	25	35,89	203380045	30	59,36
46	386,0	372,21	201380046	25	13,17	202380046	25	37,56	203380046	30	62,17
47	394,1	380,29	201380047	25	13,76						
48	402,1	388,36	201380048	25	14,37	202380048	25	41,06	203380048	30	67,97
49	410,2	396,44	201380049	25	14,99						
50	418,3	404,52	201380050	25	15,63	202380050	25	44,70	203380050	30	74,01



CORONE PER CATENE A RULLI - DIN 8187 - ISO 606

PLATE WHEELS FOR ROLLER CHAINS - DIN 8187 - ISO 606

1" x 17,02 mm
25,4 x 17,02 mm
Rullo 15,88 mm
16B - 1 - 2 - 3

B1	B2	B3	b1	C	r3
16,2	47,7	79,6	15,8	2,5	26

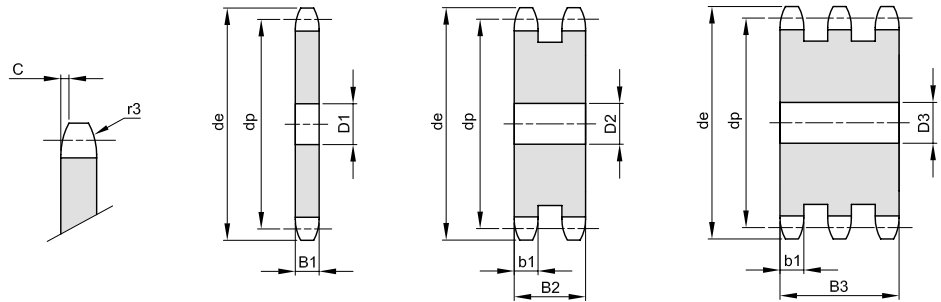

Z	de	dp	semplici			doppi			tripli		
			codice	D1	Kg.	codice	D2	Kg.	codice	D3	Kg.
51	426,4	412,60	201380051	30	16,25						
52	434,5	420,67	201380052	30	16,90	202380052	30	48,40	203380052	40	79,98
53	442,5	428,75	201380053	30	17,58						
54	450,6	436,85	201380054	30	18,26						
55	458,7	444,93	201380055	30	18,96	202380055	30	54,38	203380055	40	89,92
56	466,8	453,01	201380056	30	19,67	202380056	40	56,24			
57	474,9	461,07	201380057	30	20,50	202380057	40	58,35	203380057	40	96,87
58	482,9	469,16	201380058	30	21,13						
60	499,1	485,32	201380060	30	22,65	202380060	40	64,90	203380060	40	107,78
62	515,3	501,50	201380062	30	24,22	202380062	40	69,46			
64	531,4	517,65	201380064	30	25,84						
65	539,5	525,73	201380065	30	26,67	202380065	40	76,59	203380065	40	127,24
68	563,8	549,98	201380068	30	29,23	202380068	40	84,07			
70	579,9	566,14	201380070	30	31,01	202380070	40	89,24	203380070	40	148,31
72	596,1	582,32	201380072	30	32,84	202380072	40	94,60	203380072	40	157,18
75	620,3	606,55	201380075	30	35,68	202380075	40	102,85			
76	628,4	614,65	201380076	30	36,65	202380076	40	105,69	203380076	40	175,70
78	644,6	630,80	201380078	30	38,64						
80	660,7	646,96	201380080	30	40,68	202380080	40	117,43	203380080	40	195,25
85	701,2	687,40	201380085	30	46,00	202380085	40	132,96	203380085	40	221,13
90	741,6	727,81	201380090	30	51,65	202380090	40	149,46	203380090	40	248,61
95	782,0	768,22	201380095	30	57,62	202380095	40	166,91	203380095	40	277,70
100	822,4	808,63	201380100	30	63,62	202380100	40	181,33			
110	903,3	889,48	201380110	30	77,50						
114	935,6	921,82	201380114	30	83,31	202380114	40	242,01	203380114	40	402,85
120	984,1	970,33	201380120	30	92,40						
125	1024,5	1010,73	201380125	30	100,33	202380125	40	291,84	203380125	40	485,90



CORONE PER CATENE A RULLI - DIN 8187 - ISO 606

PLATE WHEELS FOR ROLLER CHAINS - DIN 8187 - ISO 606

1"1/4 x 3/4"
31,75 x 19,56 mm
 Rullo 19,05 mm
20B - 1 - 2 - 3

B1	B2	B3	b1	C	r3
18,5	54,6	91	18,2	3,5	32

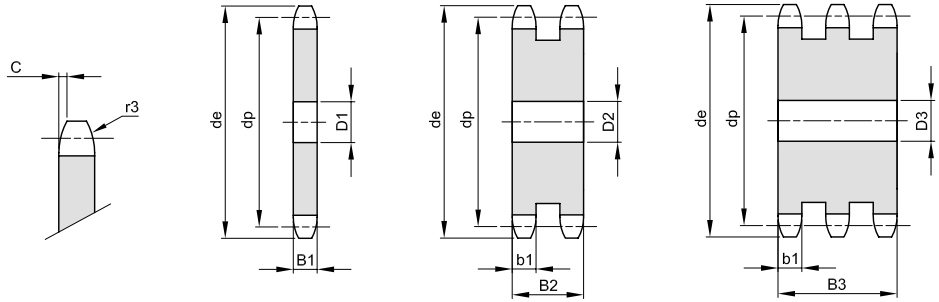

Z	de	dp	semplici			doppi			tripli		
			codice	D1	Kg.	codice	D2	Kg.	codice	D3	Kg.
8	96,0	82,96	201400008	16	0,55	202400008	20	1,28	203400008	20	2,02
9	106,5	92,84	201400009	16	0,73	202400009	20	1,74	203400009	20	2,79
10	117,0	102,74	201400010	16	0,93	202400010	20	2,28	203400010	20	3,77
11	127,0	112,68	201400011	20	1,13	202400011	20	2,89	203400011	25	4,53
12	137,0	122,68	201400012	20	1,38	202400012	20	3,56	203400012	25	5,64
13	147,5	132,65	201400013	20	1,65	202400013	20	4,31	203400013	25	4,87
14	157,6	142,68	201400014	20	1,94	202400014	20	5,12	203400014	25	8,20
15	167,7	152,72	201400015	20	2,26	202400015	20	6,00	203400015	25	9,65
16	177,7	162,75	201400016	20	2,60	202400016	30	6,78	203400016	30	11,07
17	187,7	172,78	201400017	20	2,96	202400017	30	7,80	203400017	30	12,75
18	197,8	182,85	201400018	20	3,34	202400018	30	8,89	203400018	30	14,54
19	207,9	192,91	201400019	20	3,75	202400019	30	10,05	203400019	30	16,45
20	217,9	202,98	201400020	20	4,30	202400020	30	11,27	203400020	30	18,47
21	228,0	213,04	201400021	25	4,62	202400021	30	12,56	203400021	30	20,62
22	238,1	223,11	201400022	25	5,09	202400022	30	13,93	203400022	30	22,87
23	248,2	233,17	201400023	25	5,60	202400023	30	15,36	203400023	30	25,24
24	258,3	243,23	201400024	25	6,18	202400024	30	16,86	203400024	30	27,72
25	268,4	253,33	201400025	25	6,67	202400025	30	18,43	203400025	30	30,32
26	278,4	263,40	201400026	30	7,21	202400026	30	20,07	203400026	30	33,03
27	288,5	273,48	201400027	30	7,81	202400027	30	21,17	203400027	30	35,86
28	298,5	283,56	201400028	30	8,43	202400028	30	23,56	203400028	30	38,80
29	308,6	293,65	201400029	30	9,07	202400029	30	25,39			
30	318,7	303,75	201400030	30	9,73	202400030	30	27,30	203400030	30	45,03
31	328,8	313,85	201400031	30	10,42	202400031	30	29,29			
32	338,9	323,91	201400032	30	11,13	202400032	30	31,34	203400032	30	51,72
33	349,0	334,01	201400033	30	11,87						
34	359,1	344,10	201400034	30	12,63	202400034	30	35,64	203400034	30	58,86
35	369,2	354,20	201400035	30	13,41	202400035	30	37,90	203400035	30	62,60
36	379,2	364,30	201400036	30	14,22	202400036	30	40,22	203400036	30	66,46
37	389,3	374,39	201400037	30	15,04						
38	399,4	384,49	201400038	30	15,90	202400038	30	45,08	203400038	30	74,52
39	409,5	394,59	201400039	30	16,77						
40	419,6	404,66	201400040	30	17,67	202400040	30	50,21	203400040	30	83,04
41	430,7	414,78	201400041	30	18,59						
42	440,8	424,88	201400042	30	19,54	202400042	30	55,62			
43	450,9	434,97	201400043	30	20,50						
44	461,0	445,07	201400044	30	21,50						
45	471,1	455,17	201400045	30	22,51	202400045	30	64,25	203400045	40	105,96
46	481,2	465,26	201400046	30	23,55	202400046	30	67,26			
48	501,4	485,46	201400048	30	25,70	202400048	30	73,49			
50	521,6	505,65	201400050	30	27,93	202400050	30	80,00	203400050	40	132,13
52	541,8	525,84	201400052	30	30,27	202400052	40	86,55			
54	562,0	546,07	201400054	30	32,69						



CORONE PER CATENE A RULLI - DIN 8187 - ISO 606

PLATE WHEELS FOR ROLLER CHAINS - DIN 8187 - ISO 606

1"1/4 x 3/4"
31,75 x 19,56 mm
 Rullo 19,05 mm
20B - 1 - 2 - 3

B1	B2	B3	b1	C	r3
18,5	54,6	91	18,2	3,5	32

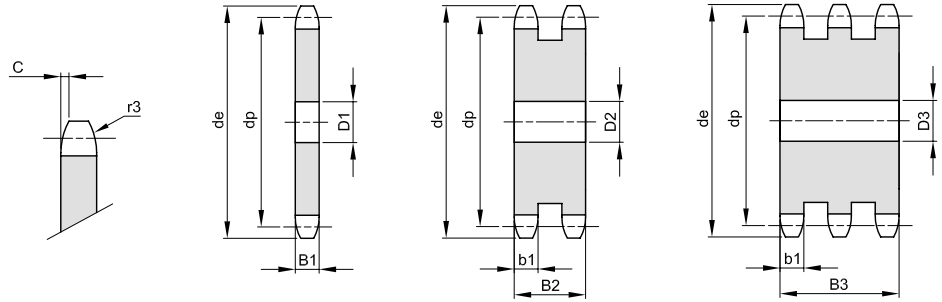

Z	de	dp	semplici			doppi			tripli		
			codice	D1	Kg.	codice	D2	Kg.	codice	D3	Kg.
55	572,1	556,16	201400055	30	33,94				203400055	40	161,16
56	582,2	566,26	201400056	30	35,21						
57	592,3	576,36	201400057	30	36,51	202400057	40	104,71	203400057	40	173,58
58	602,4	586,45	201400058	30	37,82						
60	622,6	606,65	201400060	30	40,53	202400060	40	116,43	203400060	40	193,06
64	663,0	647,06	201400064	30	46,22						
65	673,1	657,16	201400065	30	47,70	202400065	40	137,34	203400065	40	227,83
70	723,6	707,67	201400070	30	55,45	202400070	40	159,97	203400070	40	265,46
75	774,2	758,19	201400075	30	63,79						
76	784,3	768,32	201400076	30	66,53	202400076	40	189,39	203400076	40	314,39
80	824,7	808,72	201400080	30	72,71	202400080	40	210,38			
85	875,2	859,25	201400085	30	82,21						
90	925,7	909,76	201400090	30	92,30						
95	976,2	960,28	201400095	30	102,96	202400095	40	298,90			
100	1026,7	1010,79	201400100	40	114,13						
114	1168,2	1152,26	201400114	40	148,73	202400114	40	433,24	203400114	40	720,16



CORONE PER CATENE A RULLI - DIN 8187 - ISO 606

PLATE WHEELS FOR ROLLER CHAINS - DIN 8187 - ISO 606

1"1/2 x 1"
38,1 x 25,4 mm
 Rullo 25,4 mm
24B - 1 - 2 - 3

B1	B2	B3	b1	C	r3
24,1	72	120,3	23,6	4	38

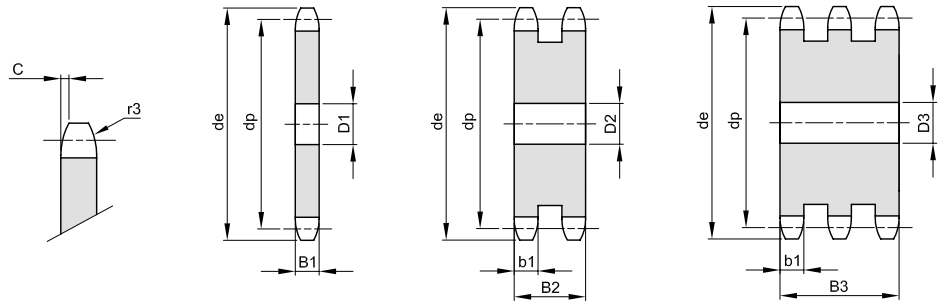

Z	de	dp	semplici			doppi			tripli		
			codice	D1	Kg.	codice	D2	Kg.	codice	D3	Kg.
8	113,0	99,55	201420008	20	1,00	202420008	25	2,31	203420008	25	3,67
9	125,0	111,40	201420009	20	1,32	202420009	25	3,18	203420009	25	5,10
10	137,0	123,29	201420010	20	1,69	202420010	25	4,19	203420010	25	6,75
11	149,0	135,21	201420011	25	2,07	202420011	25	5,33	203420011	30	8,42
12	161,0	147,22	201420012	25	2,53	202420012	25	6,59	203420012	30	10,50
13	173,0	159,18	201420013	25	3,03	202420013	25	7,99	203420013	30	12,81
14	185,0	171,22	201420014	25	3,57	202420014	25	9,52	203420014	30	15,33
15	197,0	183,26	201420015	25	4,16	202420015	25	11,18	203420015	30	18,08
16	209,0	195,30	201420016	25	4,79	202420016	30	12,85	203420016	30	21,04
17	221,0	207,34	201420017	25	5,47	202420017	30	14,77	203420017	30	24,22
18	233,0	219,42	201420018	25	6,19	202420018	30	16,82	203420018	30	27,61
19	245,5	231,49	201420019	25	6,95	202420019	30	19,00	203420019	30	31,23
20	257,5	243,57	201420020	25	7,76	202420020	30	21,31	203420020	30	35,06
21	270,5	255,65	201420021	30	8,57	202420021	30	23,75	203420021	40	38,60
22	282,5	267,73	201420022	30	9,46	202420022	30	26,33	203420022	40	42,87
23	294,5	279,80	201420023	30	10,40	202420023	30	29,03	203420023	40	47,36
24	307,0	291,88	201420024	30	11,50	202420024	30	31,86	203420024	40	52,07
25	319,0	304,00	201420025	30	12,41	202420025	30	34,83	203420025	40	56,99
26	331,0	316,08	201420026	30	13,47	202420026	30	37,93	203420026	40	62,14
27	343,0	328,19	201420027	30	14,59	202420027	30	41,15	203420027	40	67,50
28	355,0	340,27	201420028	30	15,74	202420028	30	44,51	203420028	40	73,08
29	367,5	352,38	201420029	30	16,94	202420029	30	48,00			
30	379,5	364,50	201420030	30	18,91	202420030	30	51,61	203420030	40	84,90
31	391,5	376,62	201420031	30	19,47	202420031	40	55,05			
32	403,5	388,69	201420032	30	20,80	202420032	40	58,93	203420032	40	97,59
33	415,5	400,81	201420033	30	22,18	202420033	40	62,94			
34	428,0	412,93	201420034	30	23,60	202420034	40	67,08			
35	440,0	425,04	201420035	30	25,06	202420035	40	71,35	203420035	40	118,26
36	452,0	437,16	201420036	30	26,60	202420036	40	75,75			
37	464,0	449,27	201420037	30	28,12	202420037	40	80,28			
38	476,5	461,39	201420038	30	29,71	202420038	40	84,95	203420038	40	140,90
40	501,5	485,62	201420040	30	33,03	202420040	40	94,66	203420040	40	158,08
41	513,5	497,74	201420041	30	34,75						
42	525,5	509,85	201420042	30	36,52	202420042	40	104,90			
45	562,0	546,20	201420045	30	42,08	202420045	40	121,24	203420045	40	201,37
46	574,0	558,32	201420046	30	44,03						
48	598,5	582,55	201420048	30	48,04	202420048	40	138,75	203420048	40	230,56
50	622,5	606,78	201420050	30	52,24	202420050	40	151,08	203420050	40	251,11
52	647,0	631,01	201420052	30	56,60						
54	671,0	655,25	201420054	30	61,14						
55	683,5	667,40	201420055	30	63,48						
56	695,5	679,50	201420056	30	65,86						
57	707,5	691,63	201420057	30	68,28	202420057	40	198,34	203420057	40	329,92



CORONE PER CATENE A RULLI - DIN 8187 - ISO 606
PLATE WHEELS FOR ROLLER CHAINS - DIN 8187 - ISO 606

1"1/2 x 1"
38,1 x 25,4 mm
Rullo 25,4 mm
24B - 1 - 2 - 3

B1	B2	B3	b1	C	r3
24,1	72	120,3	23,6	4	38

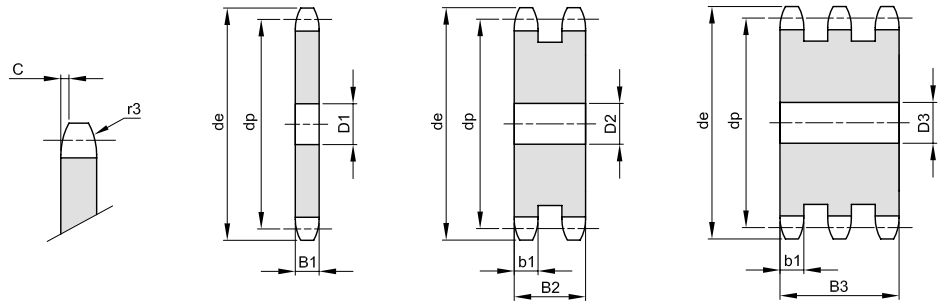

Z	de	dp	semplici			doppi			tripli		
			codice	D1	Kg.	codice	D2	Kg.	codice	D3	Kg.
60	745,0	727,97	201420060	30	75,82	202420060	40	220,55	203420060	40	366,97
62	769,0	752,24	201420062	40	80,95						
65	805,5	788,59	201420065	40	89,14	202420065	40	260,19			
70	866,0	849,21	201420070	40	103,77						
76	939,0	921,98	201420076	40	122,54	202420076	40	358,88	203420076	40	597,76
80	987,5	970,44	201420080	40	135,99						
85	1048,0	1031,10	201420085	40	153,79						
95	1169,0	1152,33	201420095	40	192,67	202420095	40	583,00			



CORONE PER CATENE A RULLI - DIN 8187 - ISO 606

PLATE WHEELS FOR ROLLER CHAINS - DIN 8187 - ISO 606

1"3/4 x 1"1/4
44,45 x 30,99 mm
 Rullo 27,94 mm
28B - 1 - 2 - 3

B1	B2	B3	b1	C	r3
29,4	88,4	148	28,8	5	44

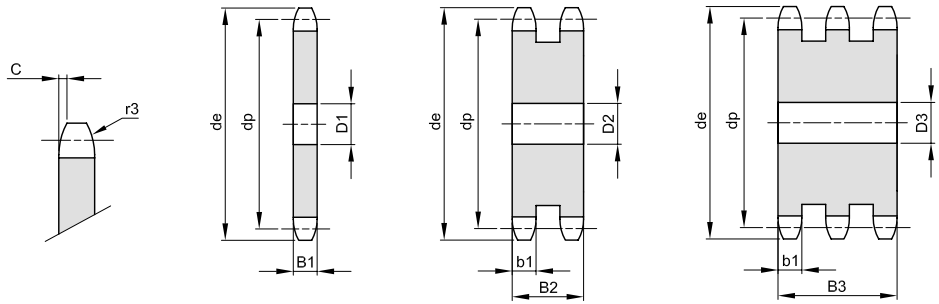

Z	de	dp	semplici			doppi			tripli		
			codice	D1	Kg.	codice	D2	Kg.	codice	D3	Kg.
8	132,0	116,15	201440008	20	1,71	202440008	25	4,01	203440008	25	6,39
9	146,0	129,96	201440009	20	2,26	202440009	25	5,48	203440009	25	8,80
10	160,0	143,85	201440010	20	2,88	202440010	25	7,17	203440010	25	11,56
11	174,0	157,77	201440011	25	3,53	202440011	30	8,92	203440011	30	14,44
12	188,0	171,74	201440012	25	4,29	202440012	30	11,04	203440012	30	17,93
13	204,0	185,75	201440013	25	5,12	202440013	30	13,38	203440013	30	21,79
14	218,0	199,76	201440014	25	6,03	202440014	30	15,94	203440014	30	26,02
15	232,0	213,79	201440015	25	7,01	202440015	30	18,72	203440015	30	30,61
16	246,0	227,84	201440016	30	8,02	202440016	30	21,71	203440016	30	35,57
17	260,0	241,90	201440017	30	9,14	202440017	30	24,92	203440017	30	40,89
18	274,0	255,98	201440018	30	10,34	202440018	30	28,36	203440018	30	46,58
19	289,0	270,06	201440019	30	11,61	202440019	30	32,00	203440019	30	52,64
20	303,0	284,15	201440020	30	12,95	202440020	30	35,87	203440020	30	59,06
21	317,0	298,24	201440021	30	14,37	202440021	30	39,96	203440021	40	65,20
22	331,0	312,34	201440022	30	15,86	202440022	30	44,26			
23	345,0	326,44	201440023	30	17,42	202440023	30	48,78	203440023	40	79,87
24	359,0	340,55	201440024	30	19,05						
25	373,0	354,66	201440025	30	20,76	202440025	30	58,50	203440025	40	95,99
26	387,0	368,77	201440026	30	22,54	202440026	40	63,28			
27	401,0	382,88	201440027	30	24,39						
28	416,0	397,00	201440028	30	26,32	202440028	40	74,29			
30	444,0	425,24	201440030	30	30,38	202440030	40	86,17	203440030	40	142,70
32	472,0	453,49	201440032	30	34,74						
34	500,0	481,75	201440034	30	39,38						
35	514,0	495,88	201440035	30	41,82	202440035	40	119,69			
36	529,0	510,01	201440036	30	44,32						
38	557,0	538,27	201440038	30	49,55	202440038	40	142,42	203440038	40	236,43
40	585,0	566,54	201440040	30	55,07	202440040	40	158,67	203440040	40	263,52
45	656,0	637,22	201440045	30	70,13	202440045	40	203,10	203440045	40	337,73
50	726,0	707,91	201440050	30	87,01	202440050	40	252,99			
57	825,0	806,90	201440057	40	113,56	202440057	40	332,00	203440057	40	552,76
60	869,0	849,32	201440060	40	126,08						
76	1095,0	1075,62	201440076	40	203,89	202440076	40	600,35	203440076	40	1000,97



CORONE PER CATENE A RULLI - DIN 8187 - ISO 606

PLATE WHEELS FOR ROLLER CHAINS - DIN 8187 - ISO 606

2" x 1"1/4
50,8 x 30,99 mm
 Rullo 29,21 mm
32B - 1 - 2 - 3

B1	B2	B3	b1	C	r3
29,4	87,4	146	28,8	6	51

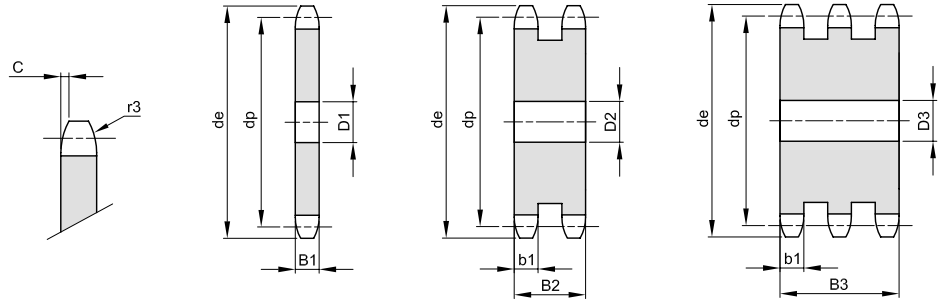

Z	de	dp	semplici			doppi			tripli		
			codice	D1	Kg.	codice	D2	Kg.	codice	D3	Kg.
8	152,0	132,74	201460008	25	2,27	202460008	25	5,53	203460008	25	8,83
9	168,0	148,54	201460009	25	2,99	202460009	25	7,46	203460009	25	11,99
10	184,0	164,39	201460010	25	3,81	202460010	25	9,68	203460010	25	15,63
11	200,0	180,31	201460011	30	4,67	202460011	35	11,86	203460011	35	19,20
12	216,0	196,29	201460012	30	5,67	202460012	35	14,64	203460012	35	23,78
13	235,0	212,29	201460013	30	6,77	202460013	35	17,70	203460013	35	28,83
14	251,0	228,29	201460014	30	7,97	202460014	35	21,05	203460014	35	34,35
15	267,0	244,30	201460015	30	9,26	202460015	35	24,68	203460015	35	40,34
16	283,0	260,40	201460016	30	10,64	202460016	40	28,38	203460016	40	46,47
17	299,0	276,46	201460017	30	12,12	202460017	40	32,57	203460017	40	53,40
18	315,0	292,55	201460018	30	13,69	202460018	40	37,05	203460018	40	60,80
19	331,0	308,66	201460019	30	15,36	202460019	40	41,80	203460019	40	68,68
20	347,0	324,71	201460020	40	16,99	202460020	40	46,84	203460020	40	77,02
21	363,0	340,82	201460021	40	18,85	202460021	40	52,15	203460021	40	85,84
22	379,0	356,98	201460022	40	20,80	202460022	40	57,75			
23	396,0	373,08	201460023	40	22,85	202460023	40	63,63	203460023	40	104,88
24	412,0	389,18	201460024	40	24,99	202460024	40	69,80			
25	428,0	405,33	201460025	40	27,23	202460025	40	76,24	203460025	40	125,81
26	444,0	421,44	201460026	40	29,56	202460026	40	82,97			
28	476,0	453,69	201460028	40	34,51	202460028	40	97,27			
30	508,0	486,00	201460030	40	39,84	202460030	40	112,70	203460030	40	186,37
32	541,0	518,27	201460032	40	45,54						
35	589,0	566,71	201460035	40	54,81	202460035	40	156,19	203460035	40	258,69
38	638,0	615,16	201460038	40	64,93	202460038	40	185,67	203460038	40	307,73
40	670,0	647,47	201460040	40	72,16	202460040	40	206,73			
45	751,0	728,24	201460045	40	91,87	202460045	40	265,32	203460045	40	438,64
50	832,0	809,04	201460050	40	113,96	202460050	40	328,95	203460050	40	549,27
57	945,0	922,16	201460057	40	148,86	202460057	40	431,27	203460057	40	716,72
60	993,0	970,65	201460060	40	165,24						
76	1252,0	1229,27	201460076	40	267,00	202460076	40	757,78	203460076	40	1295,64