

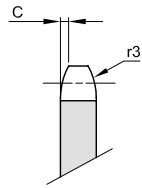

3/8" x 7/32"
9,525 x 5,72 mm
Rullo 6,35 mm
06B-1



B1	C	r3
5,3	1	10

Materiale: Acciaio C45 - tipo ^ eseguiti con cava e un foro a 90°

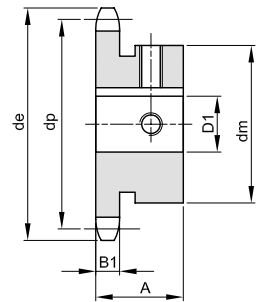
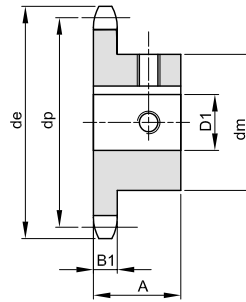

TIPO *

Z	de	dp	codice	dm	D1	A	Kg.
10	34,5	30,82	SB101330010010	24*	10^	20	0,06
10	34,5	30,82	SB101330010012	26*	12	20	0,07
10	34,5	30,82	SB101330010014	29*	14	20	0,07
11	37,5	33,80	SB101330011010	24*	10^	25	0,09
11	37,5	33,80	SB101330011012	26*	12	25	0,09
11	37,5	33,80	SB101330011014	29*	14	25	0,10
11	37,5	33,80	SB101330011015	30*	15	25	0,10
11	37,5	33,80	SB101330011016	31*	16	25	0,11
12	40,5	36,80	SB101330012010	25	10^	25	0,10
12	40,5	36,80	SB101330012012	26*	12	25	0,10
12	40,5	36,80	SB101330012014	29*	14	25	0,11
12	40,5	36,80	SB101330012015	30*	15	25	0,11
12	40,5	36,80	SB101330012016	31*	16	25	0,11
13	43,5	39,80	SB101330013010	28	10^	25	0,13
13	43,5	39,80	SB101330013012	28	12	25	0,12
13	43,5	39,80	SB101330013014	28	14	25	0,11
13	43,5	39,80	SB101330013015	28	15	25	0,11
13	43,5	39,80	SB101330013016	31*	16	25	0,12
13	43,5	39,80	SB101330013018	34*	18	25	0,13
14	46,5	42,80	SB101330014010	31	10^	25	0,16
14	46,5	42,80	SB101330014012	31	12	25	0,15
14	46,5	42,80	SB101330014014	31	14	25	0,17
14	46,5	42,80	SB101330014015	31	15	25	0,14
14	46,5	42,80	SB101330014016	31	16	25	0,13
14	46,5	42,80	SB101330014018	31	18	25	0,12
14	46,5	42,80	SB101330014019	35*	19	25	0,14
15	49,5	45,81	SB101330015012	34	12	25	0,18
15	49,5	45,81	SB101330015014	34	14	25	0,18
15	49,5	45,81	SB101330015015	34	15	25	0,17
15	49,5	45,81	SB101330015016	34	16	25	0,17
15	49,5	45,81	SB101330015018	34	18	25	0,15
15	49,5	45,81	SB101330015019	34	19	25	0,15
15	49,5	45,81	SB101330015020	34	20	25	0,14
15	49,5	45,81	SB101330015022	42*	22	25	0,19
15	49,5	45,81	SB101330015024	42*	24	25	0,17
15	49,5	45,81	SB101330015025	42*	25	25	0,16
16	52,5	48,82	SB101330016012	37	12	28	0,24
16	52,5	48,82	SB101330016014	37	14	28	0,23
16	52,5	48,82	SB101330016015	37	15	28	0,23
16	52,5	48,82	SB101330016016	37	16	28	0,22
16	52,5	48,82	SB101330016018	37	18	28	0,21
16	52,5	48,82	SB101330016019	37	19	28	0,20
16	52,5	48,82	SB101330016020	37	20	28	0,20

Z	de	dp	codice	dm	D1	A	Kg.
16	52,5	48,82	SB101330016022	37	22	28	0,18
16	52,5	48,82	SB101330016024	42*	24	28	0,21
16	52,5	48,82	SB101330016025	42*	25	28	0,20
17	55,5	51,83	SB101330017012	40	12	28	0,28
17	55,5	51,83	SB101330017014	40	14	28	0,28
17	55,5	51,83	SB101330017015	40	15	28	0,27
17	55,5	51,83	SB101330017016	40	16	28	0,26
17	55,5	51,83	SB101330017018	40	18	28	0,25
17	55,5	51,83	SB101330017019	40	19	28	0,24
17	55,5	51,83	SB101330017020	40	20	28	0,24
17	55,5	51,83	SB101330017022	40	22	28	0,23
17	55,5	51,83	SB101330017024	46*	24	28	0,26
17	55,5	51,83	SB101330017025	46*	25	28	0,26
18	58,6	54,85	SB101330018012	40	12	28	0,30
18	58,6	54,85	SB101330018014	40	14	28	0,28
18	58,6	54,85	SB101330018015	43	15	28	0,31
18	58,6	54,85	SB101330018016	43	16	28	0,31
18	58,6	54,85	SB101330018018	43	18	28	0,29
18	58,6	54,85	SB101330018019	43	19	28	0,29
18	58,6	54,85	SB101330018020	43	20	28	0,28
18	58,6	54,85	SB101330018022	43	22	28	0,27
18	58,6	54,85	SB101330018024	43	24	28	0,25
18	58,6	54,85	SB101330018025	43	25	28	0,24
19	61,6	57,87	SB101330019012	40	12	28	0,31
19	61,6	57,87	SB101330019014	40	14	28	0,30
19	61,6	57,87	SB101330019015	45	15	28	0,35
19	61,6	57,87	SB101330019016	45	16	28	0,35
19	61,6	57,87	SB101330019018	45	18	28	0,33
19	61,6	57,87	SB101330019019	45	19	28	0,33
19	61,6	57,87	SB101330019020	45	20	28	0,32
19	61,6	57,87	SB101330019022	45	22	28	0,31
19	61,6	57,87	SB101330019024	45	24	28	0,29
19	61,6	57,87	SB101330019025	45	25	28	0,28
20	64,6	60,89	SB101330020012	40	12	28	0,32
20	64,6	60,89	SB101330020014	40	14	28	0,31
20	64,6	60,89	SB101330020015	46	15	28	0,38
20	64,6	60,89	SB101330020016	46	16	28	0,37
20	64,6	60,89	SB101330020018	46	18	28	0,36
20	64,6	60,89	SB101330020019	46	19	28	0,35
20	64,6	60,89	SB101330020020	46	20	28	0,34
20	64,6	60,89	SB101330020022	46	22	28	0,33
20	64,6	60,89	SB101330020024	46	24	28	0,31
20	64,6	60,89	SB101330020025	46	25	28	0,30



1/2" x 5/16"
12,7 x 7,75 mm
Rullo 8,51 mm
08B-1

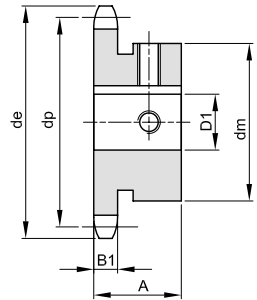
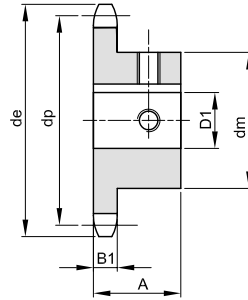
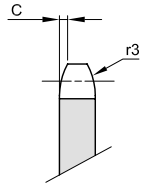

TIPO *

B1	C	r3
7,2	1,3	13

Materiale: Acciaio C45

Z	de	dp	codice	dm	D1	A	Kg.
10	45,9	41,10	SB101340010012	26	12	25	0,12
10	45,9	41,10	SB101340010014	26	14	25	0,11
10	45,9	41,10	SB101340010015	31*	15	25	0,12
10	45,9	41,10	SB101340010016	31*	16	25	0,12
11	49,9	45,07	SB101340011012	29	12	25	0,15
11	49,9	45,07	SB101340011014	29	14	25	0,14
11	49,9	45,07	SB101340011015	31*	15	25	0,14
11	49,9	45,07	SB101340011016	31*	16	25	0,14
11	49,9	45,07	SB101340011018	37*	18	25	0,16
11	49,9	45,07	SB101340011019	37*	19	25	0,16
12	53,9	49,07	SB101340012012	33	12	28	0,21
12	53,9	49,07	SB101340012014	33	14	28	0,20
12	53,9	49,07	SB101340012015	33	15	28	0,19
12	53,9	49,07	SB101340012016	33	16	28	0,19
12	53,9	49,07	SB101340012018	33	18	28	0,18
12	53,9	49,07	SB101340012019	33	19	28	0,17
12	53,9	49,07	SB101340012020	33	20	28	0,17
12	53,9	49,07	SB101340012022	40*	22	28	0,20
12	53,9	49,07	SB101340012024	41*	24	28	0,19
12	53,9	49,07	SB101340012025	42*	25	28	0,19
13	57,9	56,06	SB101340013012	33	12	28	0,27
13	57,9	56,06	SB101340013014	33	14	28	0,26
13	57,9	56,06	SB101340013015	37	15	28	0,26
13	57,9	56,06	SB101340013016	37	16	28	0,25
13	57,9	56,06	SB101340013018	37	18	28	0,24
13	57,9	56,06	SB101340013019	37	19	28	0,23
13	57,9	56,06	SB101340013020	37	20	28	0,22
13	57,9	56,06	SB101340013022	37	22	28	0,21
13	57,9	56,06	SB101340013024	42*	24	28	0,22
13	57,9	56,06	SB101340013025	42*	25	28	0,21
13	57,9	56,06	SB101340013028	45*	28	28	0,21
14	61,9	57,07	SB101340014012	37	12	28	0,32
14	61,9	57,07	SB101340014014	37	14	28	0,31
14	61,9	57,07	SB101340014015	41	15	28	0,31
14	61,9	57,07	SB101340014016	41	16	28	0,30
14	61,9	57,07	SB101340014018	41	18	28	0,29
14	61,9	57,07	SB101340014019	41	19	28	0,28
14	61,9	57,07	SB101340014020	41	20	28	0,28
14	61,9	57,07	SB101340014022	41	22	28	0,27
14	61,9	57,07	SB101340014024	41	24	28	0,25
14	61,9	57,07	SB101340014025	41	25	28	0,24
14	61,9	57,07	SB101340014028	48*	28	28	0,27
15	65,9	61,09	SB101340015012	37	12	28	0,37
15	65,9	61,09	SB101340015014	37	14	28	0,36
15	65,9	61,09	SB101340015015	45	15	28	0,37

Z	de	dp	codice	dm	D1	A	Kg.
15	65,9	61,09	SB101340015016	45	16	28	0,37
15	65,9	61,09	SB101340015018	45	18	28	0,36
15	65,9	61,09	SB101340015019	45	19	28	0,35
15	65,9	61,09	SB101340015020	45	20	28	0,34
15	65,9	61,09	SB101340015022	45	22	28	0,32
15	65,9	61,09	SB101340015024	45	24	28	0,31
15	65,9	61,09	SB101340015025	45	25	28	0,30
15	65,9	61,09	SB101340015028	45	28	28	0,27
15	65,9	61,09	SB101340015030	52*	30	28	0,32
15	65,9	61,09	SB101340015032	52*	32	28	0,30
16	69,9	65,10	SB101340016015	50	15	28	0,47
16	69,9	65,10	SB101340016016	50	16	28	0,46
16	69,9	65,10	SB101340016018	50	18	28	0,44
16	69,9	65,10	SB101340016019	50	19	28	0,43
16	69,9	65,10	SB101340016020	50	20	28	0,43
16	69,9	65,10	SB101340016022	50	22	28	0,40
16	69,9	65,10	SB101340016024	50	24	28	0,39
16	69,9	65,10	SB101340016025	50	25	28	0,38
16	69,9	65,10	SB101340016028	50	28	28	0,35
16	69,9	65,10	SB101340016030	50	30	28	0,34
16	69,9	65,10	SB101340016032	57*	32	28	0,40
17	74,0	69,11	SB101340017015	52	15	28	0,51
17	74,0	69,11	SB101340017016	52	16	28	0,51
17	74,0	69,11	SB101340017018	52	18	28	0,49
17	74,0	69,11	SB101340017019	52	19	28	0,48
17	74,0	69,11	SB101340017020	52	20	28	0,47
17	74,0	69,11	SB101340017022	52	22	28	0,45
17	74,0	69,11	SB101340017024	52	24	28	0,44
17	74,0	69,11	SB101340017025	52	25	28	0,43
17	74,0	69,11	SB101340017028	52	28	28	0,40
17	74,0	69,11	SB101340017030	52	30	28	0,39
17	74,0	69,11	SB101340017032	52	32	28	0,38
18	78,0	73,14	SB101340018016	52	16	28	0,53
18	78,0	73,14	SB101340018018	52	18	28	0,51
18	78,0	73,14	SB101340018019	52	19	28	0,50
18	78,0	73,14	SB101340018020	52	20	28	0,55
18	78,0	73,14	SB101340018022	56	22	28	0,53
18	78,0	73,14	SB101340018024	56	24	28	0,52
18	78,0	73,14	SB101340018025	56	25	28	0,51
18	78,0	73,14	SB101340018028	56	28	28	0,48
18	78,0	73,14	SB101340018030	56	30	28	0,46
18	78,0	73,14	SB101340018032	56	32	28	0,43
18	78,0	73,14	SB101340018035	56	35	28	0,41
18	78,0	73,14	SB101340018038	56	38	28	0,39
19	82,0	77,16	SB101340019016	52	16	28	0,55



1/2" x 5/16"
12,7 x 7,75 mm
Rullo 8,51 mm
08B-1

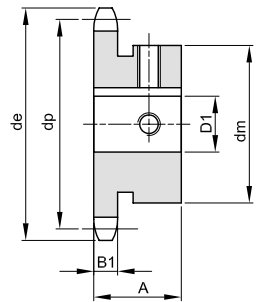
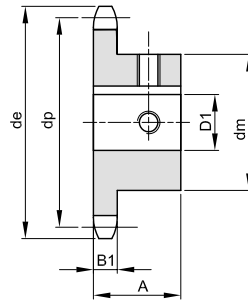
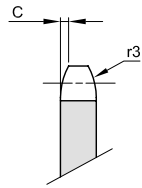

TIPO *

B1	C	r3
7,2	1,3	13

Materiale: Acciaio C45

Z	de	dp	codice	dm	D1	A	Kg.
19	82,0	77,16	SB101340019018	52	18	28	0,53
19	82,0	77,16	SB101340019019	52	19	28	0,5
19	82,0	77,16	SB101340019020	60	20	28	0,64
19	82,0	77,16	SB101340019022	60	22	28	0,62
19	82,0	77,16	SB101340019024	60	24	28	0,60
19	82,0	77,16	SB101340019025	60	25	28	0,59
19	82,0	77,16	SB101340019028	60	28	28	0,57
19	82,0	77,16	SB101340019030	60	30	28	0,55
19	82,0	77,16	SB101340019032	60	32	28	0,53
19	82,0	77,16	SB101340019035	60	35	28	0,49
19	82,0	77,16	SB101340019038	60	38	28	0,46
20	86,0	81,19	SB101340020016	55	16	28	0,64
20	86,0	81,19	SB101340020018	55	18	28	0,61
20	86,0	81,19	SB101340020019	55	19	28	0,59
20	86,0	81,19	SB101340020020	64	20	28	0,74
20	86,0	81,19	SB101340020022	64	22	28	0,72
20	86,0	81,19	SB101340020024	64	24	28	0,71
20	86,0	81,19	SB101340020025	64	25	28	0,70
20	86,0	81,19	SB101340020028	64	28	28	0,67
20	86,0	81,19	SB101340020030	64	30	28	0,65
20	86,0	81,19	SB101340020032	64	32	28	0,63
20	86,0	81,19	SB101340020035	64	35	28	0,61
20	86,0	81,19	SB101340020038	64	38	28	0,59
21	90,1	85,22	SB101340021016	55	16	28	0,74
21	90,1	85,22	SB101340021018	55	18	28	0,72
21	90,1	85,22	SB101340021019	55	19	28	0,71
21	90,1	85,22	SB101340021020	60	20	28	0,70
21	90,1	85,22	SB101340021022	60	22	28	0,68
21	90,1	85,22	SB101340021024	68	24	28	0,80
21	90,1	85,22	SB101340021025	68	25	28	0,79
21	90,1	85,22	SB101340021028	68	28	28	0,77
21	90,1	85,22	SB101340021030	68	30	28	0,75
21	90,1	85,22	SB101340021032	68	32	28	0,72
21	90,1	85,22	SB101340021035	68	35	28	0,69
21	90,1	85,22	SB101340021038	68	38	28	0,65
22	94,1	89,24	SB101340022016	55	16	28	0,84
22	94,1	89,24	SB101340022018	55	18	28	0,81
22	94,1	89,24	SB101340022019	55	19	28	0,80
22	94,1	89,24	SB101340022020	65	20	28	0,82
22	94,1	89,24	SB101340022022	65	22	28	0,80
22	94,1	89,24	SB101340022024	70	24	28	0,87
22	94,1	89,24	SB101340022025	70	25	28	0,86
22	94,1	89,24	SB101340022028	70	28	28	0,83
22	94,1	89,24	SB101340022030	70	30	28	0,81
22	94,1	89,24	SB101340022032	70	32	28	0,78

Z	de	dp	codice	dm	D1	A	Kg.
22	94,1	89,24	SB101340022035	70	35	28	0,75
22	94,1	89,24	SB101340022038	70	38	28	0,71
23	98,1	93,27	SB101340023019	65	19	28	0,86
23	98,1	93,27	SB101340023020	65	20	28	0,85
23	98,1	93,27	SB101340023022	70	22	28	0,93
23	98,1	93,27	SB101340023024	70	24	28	0,90
23	98,1	93,27	SB101340023025	70	25	28	0,89
23	98,1	93,27	SB101340023028	70	28	28	0,86
23	98,1	93,27	SB101340023030	70	30	28	0,84
23	98,1	93,27	SB101340023032	70	32	28	0,82
23	98,1	93,27	SB101340023035	70	35	28	0,79
23	98,1	93,27	SB101340023038	70	38	28	0,76
24	102,1	97,29	SB101340024019	65	19	28	0,91
24	102,1	97,29	SB101340024020	65	20	28	0,89
24	102,1	97,29	SB101340024022	70	22	28	0,92
24	102,1	97,29	SB101340024024	70	24	28	0,94
24	102,1	97,29	SB101340024025	70	25	28	0,93
24	102,1	97,29	SB101340024028	70	28	28	0,90
24	102,1	97,29	SB101340024030	70	30	28	0,88
24	102,1	97,29	SB101340024032	70	32	28	0,85
24	102,1	97,29	SB101340024035	70	35	28	0,82
24	102,1	97,29	SB101340024038	70	38	28	0,79
25	106,2	101,33	SB101340025019	65	19	28	0,94
25	106,2	101,33	SB101340025020	65	20	28	0,92
25	106,2	101,33	SB101340025022	70	22	28	0,99
25	106,2	101,33	SB101340025024	70	24	28	0,97
25	106,2	101,33	SB101340025025	70	25	28	0,97
25	106,2	101,33	SB101340025028	70	28	28	0,94
25	106,2	101,33	SB101340025030	70	30	28	0,92
25	106,2	101,33	SB101340025032	70	32	28	0,90
25	106,2	101,33	SB101340025035	70	35	28	0,86
25	106,2	101,33	SB101340025038	70	38	28	0,80
30	126,3	121,50	SB101340030025	75	25	30	1,31
30	126,3	121,50	SB101340030028	75	28	30	1,28
30	126,3	121,50	SB101340030030	80	30	30	1,37
30	126,3	121,50	SB101340030032	80	32	30	1,34
30	126,3	121,50	SB101340030035	80	35	30	1,31
30	126,3	121,50	SB101340030038	80	38	30	1,28



5/8" x 3/8"
15,875 x 9,65 mm
Rullo 10,16 mm
10B-1

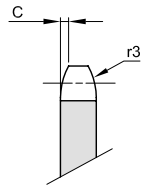

B1	C	r3
9,1	1,6	16

Materiale: Acciaio C45

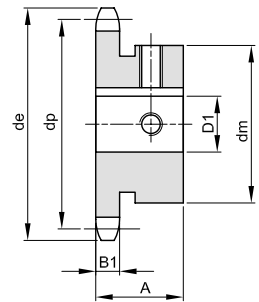
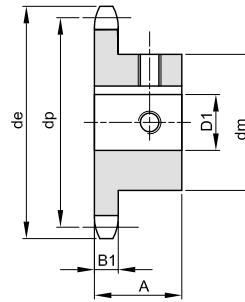

TIPO *

Z	de	dp	codice	dm	D1	A	Kg.
10	58,3	51,37	SB101350010015	35	15	25	0,21
10	58,3	51,37	SB101350010016	35	16	25	0,21
10	58,3	51,37	SB101350010018	35	18	25	0,20
10	58,3	51,37	SB101350010019	35	19	25	0,20
10	58,3	51,37	SB101350010020	35	20	25	0,18
10	58,3	51,37	SB101350010024	42*	24	25	0,21
11	63,2	56,34	SB101350011015	37	15	30	0,30
11	63,2	56,34	SB101350011016	37	16	30	0,30
11	63,2	56,34	SB101350011018	37	18	30	0,28
11	63,2	56,34	SB101350011019	37	19	30	0,27
11	63,2	56,34	SB101350011020	37	20	30	0,26
11	63,2	56,34	SB101350011024	47*	24	30	0,30
11	63,2	56,34	SB101350011025	47*	25	30	0,29
11	63,2	56,34	SB101350011028	47*	28	30	0,27
12	68,2	61,34	SB101350012015	42	15	30	0,38
12	68,2	61,34	SB101350012016	42	16	30	0,37
12	68,2	61,34	SB101350012018	42	18	30	0,35
12	68,2	61,34	SB101350012019	42	19	30	0,34
12	68,2	61,34	SB101350012020	42	20	30	0,34
12	68,2	61,34	SB101350012022	42	22	30	0,33
12	68,2	61,34	SB101350012024	42	24	30	0,31
12	68,2	61,34	SB101350012025	42	25	30	0,30
12	68,2	61,34	SB101350012028	51*	28	30	0,34
12	68,2	61,34	SB101350012030	51*	30	30	0,32
12	68,2	61,34	SB101350012032	55*	32	30	0,34
13	73,2	66,32	SB101350013015	47	15	30	0,48
13	73,2	66,32	SB101350013016	47	16	30	0,47
13	73,2	66,32	SB101350013018	47	18	30	0,45
13	73,2	66,32	SB101350013019	47	19	30	0,44
13	73,2	66,32	SB101350013020	47	20	30	0,44
13	73,2	66,32	SB101350013022	47	22	30	0,42
13	73,2	66,32	SB101350013024	47	24	30	0,40
13	73,2	66,32	SB101350013025	47	25	30	0,39
13	73,2	66,32	SB101350013028	47	28	30	0,36
13	73,2	66,32	SB101350013030	47	30	30	0,34
13	73,2	66,32	SB101350013032	57*	32	30	0,40
14	78,2	71,34	SB101350014015	52	15	30	0,57
14	78,2	71,34	SB101350014016	52	16	30	0,56
14	78,2	71,34	SB101350014018	52	18	30	0,54
14	78,2	71,34	SB101350014019	52	19	30	0,54
14	78,2	71,34	SB101350014020	52	20	30	0,53
14	78,2	71,34	SB101350014022	52	22	30	0,51
14	78,2	71,34	SB101350014024	52	24	30	0,50

Z	de	dp	codice	dm	D1	A	Kg.
14	78,2	71,34	SB101350014025	52	25	30	0,49
14	78,2	71,34	SB101350014028	52	28	30	0,46
14	78,2	71,34	SB101350014030	52	30	30	0,44
14	78,2	71,34	SB101350014032	52	32	30	0,42
15	83,2	76,36	SB101350015019	57	19	30	0,67
15	83,2	76,36	SB101350015020	57	20	30	0,65
15	83,2	76,36	SB101350015022	57	22	30	0,63
15	83,2	76,36	SB101350015024	57	24	30	0,61
15	83,2	76,36	SB101350015025	57	25	30	0,60
15	83,2	76,36	SB101350015028	57	28	30	0,57
15	83,2	76,36	SB101350015030	57	30	30	0,55
15	83,2	76,36	SB101350015032	57	32	30	0,52
15	83,2	76,36	SB101350015035	57	35	30	0,49
16	88,3	81,37	SB101350016019	60	19	30	0,76
16	88,3	81,37	SB101350016020	60	20	30	0,74
16	88,3	81,37	SB101350016022	60	22	30	0,73
16	88,3	81,37	SB101350016024	60	24	30	0,71
16	88,3	81,37	SB101350016025	60	25	30	0,70
16	88,3	81,37	SB101350016028	60	28	30	0,68
16	88,3	81,37	SB101350016030	60	30	30	0,65
16	88,3	81,37	SB101350016032	60	32	30	0,62
16	88,3	81,37	SB101350016035	60	35	30	0,58
16	88,3	81,37	SB101350016038	60	38	30	0,54
17	93,3	86,39	SB101350017019	60	19	30	0,80
17	93,3	86,39	SB101350017020	60	20	30	0,78
17	93,3	86,39	SB101350017022	60	22	30	0,76
17	93,3	86,39	SB101350017024	60	24	30	0,75
17	93,3	86,39	SB101350017025	60	25	30	0,74
17	93,3	86,39	SB101350017028	60	28	30	0,71
17	93,3	86,39	SB101350017030	60	30	30	0,69
17	93,3	86,39	SB101350017032	60	32	30	0,65
17	93,3	86,39	SB101350017035	60	35	30	0,63
17	93,3	86,39	SB101350017038	60	38	30	0,60
18	98,3	91,42	SB101350018019	60	19	30	0,85
18	98,3	91,42	SB101350018020	60	20	30	0,83
18	98,3	91,42	SB101350018022	70	22	30	0,97
18	98,3	91,42	SB101350018024	70	24	30	0,96
18	98,3	91,42	SB101350018025	70	25	30	0,95
18	98,3	91,42	SB101350018028	70	28	30	0,93
18	98,3	91,42	SB101350018030	70	30	30	0,91
18	98,3	91,42	SB101350018032	70	32	30	0,87
18	98,3	91,42	SB101350018035	70	35	30	0,84
18	98,3	91,42	SB101350018038	70	38	30	0,80



PIGNONI SEMPLICI PER CATENE A RULLI "SYSTEM BEA" - DIN 8187 - ISO 606
SIMPLEX SPROCKETS FOR ROLLER CHAINS "SYSTEM BEA" - DIN 8187 - ISO 606

5/8" x 3/8"
15,875 x 9,65 mm
Rullo 10,16 mm
10B-1

B1	C	r3
9,1	1,6	16

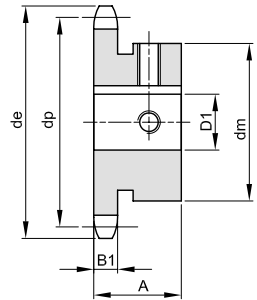
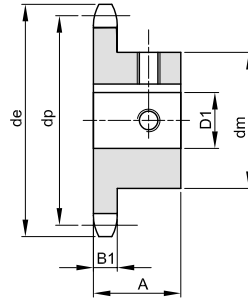
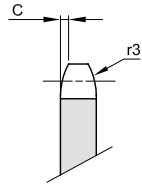

TIPO *

Materiale: Acciaio C45

Z	de	dp	codice	dm	D1	A	Kg.
18	98,3	91,42	SB101350018040	70	40	30	0,77
18	98,3	91,42	SB101350018042	70	42	30	0,74
19	103,3	96,45	SB101350019019	60	19	30	0,91
19	103,3	96,45	SB101350019020	60	20	30	0,90
19	103,3	96,45	SB101350019022	70	22	30	1,07
19	103,3	96,45	SB101350019024	70	24	30	1,02
19	103,3	96,45	SB101350019025	70	25	30	1,02
19	103,3	96,45	SB101350019028	70	28	30	1,00
19	103,3	96,45	SB101350019030	70	30	30	0,97
19	103,3	96,45	SB101350019032	70	32	30	0,94
19	103,3	96,45	SB101350019035	70	35	30	0,91
19	103,3	96,45	SB101350019038	70	38	30	0,86
19	103,3	96,45	SB101350019040	70	40	30	0,83
19	103,3	96,45	SB101350019042	70	42	30	0,80
20	108,4	101,49	SB101350020019	65	19	30	1,06
20	108,4	101,49	SB101350020020	65	20	30	1,04
20	108,4	101,49	SB101350020022	65	22	30	1,01
20	108,4	101,49	SB101350020024	70	24	30	1,08
20	108,4	101,49	SB101350020025	70	25	30	1,07
20	108,4	101,49	SB101350020028	75	28	30	1,13
20	108,4	101,49	SB101350020030	75	30	30	1,11
20	108,4	101,49	SB101350020032	75	32	30	1,08
20	108,4	101,49	SB101350020035	75	35	30	1,05
20	108,4	101,49	SB101350020038	75	38	30	1,01
20	108,4	101,49	SB101350020040	75	40	30	0,98
20	108,4	101,49	SB101350020042	75	42	30	0,95
21	113,4	106,52	SB101350021019	65	19	30	1,10
21	113,4	106,52	SB101350021020	65	20	30	1,08
21	113,4	106,52	SB101350021022	65	22	30	1,06
21	113,4	106,52	SB101350021024	70	24	30	1,13
21	113,4	106,52	SB101350021025	70	25	30	1,12
21	113,4	106,52	SB101350021028	75	28	30	1,15
21	113,4	106,52	SB101350021030	75	30	30	1,17
21	113,4	106,52	SB101350021032	75	32	30	1,14
21	113,4	106,52	SB101350021035	75	35	30	1,11
21	113,4	106,52	SB101350021038	75	38	30	1,08
21	113,4	106,52	SB101350021040	75	40	30	1,03
21	113,4	106,52	SB101350021042	75	42	30	0,99
22	118,4	111,55	SB101350022019	65	19	30	1,16
22	118,4	111,55	SB101350022020	65	20	30	1,14
22	118,4	111,55	SB101350022022	65	22	30	1,11
22	118,4	111,55	SB101350022024	70	24	30	1,20
22	118,4	111,55	SB101350022025	70	25	30	1,19

Z	de	dp	codice	dm	D1	A	Kg.
22	118,4	111,55	SB101350022028	80	28	30	1,35
22	118,4	111,55	SB101350022030	80	30	30	1,32
22	118,4	111,55	SB101350022032	80	32	30	1,29
22	118,4	111,55	SB101350022035	80	35	30	1,26
22	118,4	111,55	SB101350022038	80	38	30	1,23
22	118,4	111,55	SB101350022040	80	40	30	1,19
22	118,4	111,55	SB101350022042	80	42	30	1,17
23	123,5	116,58	SB101350023019	65	19	30	1,25
23	123,5	116,58	SB101350023020	65	20	30	1,22
23	123,5	116,58	SB101350023022	65	22	30	1,20
23	123,5	116,58	SB101350023024	70	24	30	1,27
23	123,5	116,58	SB101350023025	70	25	30	1,25
23	123,5	116,58	SB101350023028	80	28	30	1,36
23	123,5	116,58	SB101350023030	80	30	30	1,39
23	123,5	116,58	SB101350023032	80	32	30	1,36
23	123,5	116,58	SB101350023035	80	35	30	1,33
23	123,5	116,58	SB101350023038	80	38	30	1,30
23	123,5	116,58	SB101350023040	80	40	30	1,26
23	123,5	116,58	SB101350023042	80	42	30	1,20
24	128,5	121,62	SB101350024019	65	19	30	1,30
24	128,5	121,62	SB101350024020	65	20	30	1,28
24	128,5	121,62	SB101350024022	65	22	30	1,25
24	128,5	121,62	SB101350024024	70	24	30	1,34
24	128,5	121,62	SB101350024025	70	25	30	1,33
24	128,5	121,62	SB101350024028	80	28	30	1,48
24	128,5	121,62	SB101350024030	80	30	30	1,45
24	128,5	121,62	SB101350024032	80	32	30	1,42
24	128,5	121,62	SB101350024035	80	35	30	1,40
24	128,5	121,62	SB101350024038	80	38	30	1,35
24	128,5	121,62	SB101350024040	80	40	30	1,33
24	128,5	121,62	SB101350024042	80	42	30	1,30
25	133,6	126,66	SB101350025019	65	19	30	1,37
25	133,6	126,66	SB101350025020	65	20	30	1,35
25	133,6	126,66	SB101350025022	65	22	30	1,32
25	133,6	126,66	SB101350025024	70	24	30	1,41
25	133,6	126,66	SB101350025025	70	25	30	1,39
25	133,6	126,66	SB101350025028	80	28	30	1,56
25	133,6	126,66	SB101350025030	80	30	30	1,53
25	133,6	126,66	SB101350025032	80	32	30	1,50
25	133,6	126,66	SB101350025035	80	35	30	1,47
25	133,6	126,66	SB101350025038	80	38	30	1,43
25	133,6	126,66	SB101350025040	80	40	30	1,40
25	133,6	126,66	SB101350025042	80	42	30	1,38



PIGNONI SEMPLICI PER CATENE A RULLI "SYSTEM BEA" - DIN 8187 - ISO 606

SIMPLEX SPROCKETS FOR ROLLER CHAINS "SYSTEM BEA" - DIN 8187 - ISO 606

3/4" x 7/16"
19,05 x 11,68 mm
 Rullo 12,07 mm
12B-1

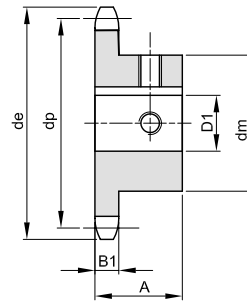
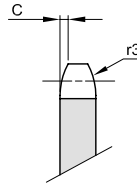

B1	C	r3
11,1	2	19

Materiale: Acciaio C45

Z	de	dp	codice	dm	D1	A	Kg.
10	69,8	61,64	SB101360010019	42	19	30	0,37
10	69,8	61,64	SB101360010020	42	20	30	0,36
10	69,8	61,64	SB101360010024	42	24	30	0,33
10	69,8	61,64	SB101360010025	42	25	30	0,32
11	75,8	67,61	SB101360011019	46	19	35	0,51
11	75,8	67,61	SB101360011020	46	20	35	0,50
11	75,8	67,61	SB101360011024	46	24	35	0,46
11	75,8	67,61	SB101360011025	46	25	35	0,45
12	81,8	73,60	SB101360012019	52	19	35	0,67
12	81,8	73,60	SB101360012020	52	20	35	0,66
12	81,8	73,60	SB101360012022	52	22	35	0,64
12	81,8	73,60	SB101360012024	52	24	35	0,61
12	81,8	73,60	SB101360012025	52	25	35	0,60
12	81,8	73,60	SB101360012028	52	28	35	0,57
12	81,8	73,60	SB101360012030	52	30	35	0,55
12	81,8	73,60	SB101360012032	56	32	35	0,59
12	81,8	73,60	SB101360012035	56	35	35	0,54
13	87,8	79,59	SB101360013019	58	19	35	0,82
13	87,8	79,59	SB101360013020	58	20	35	0,81
13	87,8	79,59	SB101360013022	58	22	35	0,80
13	87,8	79,59	SB101360013024	58	24	35	0,77
13	87,8	79,59	SB101360013025	58	25	35	0,76
13	87,8	79,59	SB101360013028	58	28	35	0,73
13	87,8	79,59	SB101360013030	58	30	35	0,70
13	87,8	79,59	SB101360013032	58	32	35	0,66
13	87,8	79,59	SB101360013035	58	35	35	0,62
13	87,8	79,59	SB101360013038	61	38	35	0,67
14	93,8	85,61	SB101360014019	60	19	35	0,92
14	93,8	85,61	SB101360014020	60	20	35	0,91
14	93,8	85,61	SB101360014022	60	22	35	0,88
14	93,8	85,61	SB101360014024	64	24	35	0,94
14	93,8	85,61	SB101360014025	64	25	35	0,93
14	93,8	85,61	SB101360014028	64	28	35	0,90
14	93,8	85,61	SB101360014030	64	30	35	0,87
14	93,8	85,61	SB101360014032	64	32	35	0,84
14	93,8	85,61	SB101360014035	64	35	35	0,80
14	93,8	85,61	SB101360014038	64	38	35	0,75
14	93,8	85,61	SB101360014040	67	40	35	0,85
15	99,8	91,63	SB101360015019	65	19	35	1,10
15	99,8	91,63	SB101360015020	65	20	35	1,08
15	99,8	91,63	SB101360015022	65	22	35	1,03
15	99,8	91,63	SB101360015024	70	24	35	1,13
15	99,8	91,63	SB101360015025	70	25	35	1,11

Z	de	dp	codice	dm	D1	A	Kg.
15	99,8	91,63	SB101360015028	70	28	35	1,09
15	99,8	91,63	SB101360015030	70	30	35	1,06
15	99,8	91,63	SB101360015032	70	32	35	1,03
15	99,8	91,63	SB101360015035	70	35	35	0,99
15	99,8	91,63	SB101360015038	70	38	35	0,95
15	99,8	91,63	SB101360015040	70	40	35	0,91
16	105,8	97,65	SB101360016019	65	19	35	1,17
16	105,8	97,65	SB101360016020	65	20	35	1,15
16	105,8	97,65	SB101360016022	65	22	35	1,12
16	105,8	97,65	SB101360016024	70	24	35	1,22
16	105,8	97,65	SB101360016025	70	25	35	1,20
16	105,8	97,65	SB101360016028	75	28	35	1,30
16	105,8	97,65	SB101360016030	75	30	35	1,25
16	105,8	97,65	SB101360016032	75	32	35	1,20
16	105,8	97,65	SB101360016035	75	35	35	1,16
16	105,8	97,65	SB101360016038	75	38	35	1,12
16	105,8	97,65	SB101360016040	75	40	35	1,08
17	111,9	103,67	SB101360017025	70	25	35	1,28
17	111,9	103,67	SB101360017028	80	28	35	1,35
17	111,9	103,67	SB101360017030	80	30	35	1,43
17	111,9	103,67	SB101360017032	80	32	35	1,40
17	111,9	103,67	SB101360017035	80	35	35	1,37
17	111,9	103,67	SB101360017038	80	38	35	1,33
17	111,9	103,67	SB101360017040	80	40	35	1,28
17	111,9	103,67	SB101360017042	80	42	35	1,23
18	117,9	109,71	SB101360018025	70	25	35	1,37
18	117,9	109,71	SB101360018028	80	28	35	1,55
18	117,9	109,71	SB101360018030	80	30	35	1,52
18	117,9	109,71	SB101360018032	80	32	35	1,49
18	117,9	109,71	SB101360018035	80	35	35	1,45
18	117,9	109,71	SB101360018038	80	38	35	1,40
18	117,9	109,71	SB101360018040	80	40	35	1,36
18	117,9	109,71	SB101360018042	80	42	35	1,32
19	123,9	115,75	SB101360019025	70	25	35	1,45
19	123,9	115,75	SB101360019028	80	28	35	1,65
19	123,9	115,75	SB101360019030	80	30	35	1,62
19	123,9	115,75	SB101360019032	80	32	35	1,57
19	123,9	115,75	SB101360019035	80	35	35	1,53
19	123,9	115,75	SB101360019038	80	38	35	1,49
19	123,9	115,75	SB101360019040	80	40	35	1,46
19	123,9	115,75	SB101360019042	80	42	35	1,42
19	123,9	115,75	SB101360019045	80	45	35	1,37
19	123,9	115,75	SB101360019048	80	48	35	1,32



3/4" x 7/16"
19,05 x 11,68 mm
Rullo 12,07 mm
12B-1

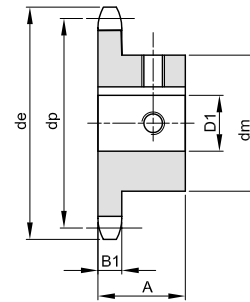
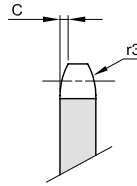

B1	C	r3
11,1	2	19

Materiale: Acciaio C45

Z	de	dp	codice	dm	D1	A	Kg.
19	123,9	115,75	SB101360019050	80	50	35	1,25
20	130,0	121,78	SB101360020025	70	25	35	1,54
20	130,0	121,78	SB101360020028	80	28	35	1,77
20	130,0	121,78	SB101360020030	80	30	35	1,72
20	130,0	121,78	SB101360020032	80	32	35	1,67
20	130,0	121,78	SB101360020035	80	35	35	1,63
20	130,0	121,78	SB101360020038	80	38	35	1,58
20	130,0	121,78	SB101360020040	80	40	35	1,55
20	130,0	121,78	SB101360020042	80	42	35	1,50
20	130,0	121,78	SB101360020045	80	45	35	1,45
20	130,0	121,78	SB101360020048	80	48	35	1,40
20	130,0	121,78	SB101360020050	80	50	35	1,36
21	136,0	127,82	SB101360021025	70	25	40	1,78
21	136,0	127,82	SB101360021028	80	28	40	2,02
21	136,0	127,82	SB101360021030	80	30	40	1,97
21	136,0	127,82	SB101360021032	90	32	40	2,23
21	136,0	127,82	SB101360021035	90	35	40	2,19
21	136,0	127,82	SB101360021038	90	38	40	2,14
21	136,0	127,82	SB101360021040	90	40	40	2,09
21	136,0	127,82	SB101360021042	90	42	40	2,04
21	136,0	127,82	SB101360021045	90	45	40	1,98
21	136,0	127,82	SB101360021048	90	48	40	1,93
21	136,0	127,82	SB101360021050	90	50	40	1,87
22	142,0	133,86	SB101360022025	70	25	40	1,90
22	142,0	133,86	SB101360022028	80	28	40	1,16
22	142,0	133,86	SB101360022030	80	30	40	1,10
22	142,0	133,86	SB101360022032	90	32	40	2,37
22	142,0	133,86	SB101360022035	90	35	40	2,31
22	142,0	133,86	SB101360022038	90	38	40	2,26
22	142,0	133,86	SB101360022040	90	40	40	2,21
22	142,0	133,86	SB101360022042	90	42	40	2,18
22	142,0	133,86	SB101360022045	90	45	40	2,13
22	142,0	133,86	SB101360022048	90	48	40	2,06
22	142,0	133,86	SB101360022050	90	50	40	1,99
23	148,1	139,90	SB101360023025	70	25	40	2,02
23	148,1	139,90	SB101360023028	80	28	40	2,28
23	148,1	139,90	SB101360023030	80	30	40	2,21
23	148,1	139,90	SB101360023032	90	32	40	2,47
23	148,1	139,90	SB101360023035	90	35	40	2,41
23	148,1	139,90	SB101360023038	90	38	40	2,36
23	148,1	139,90	SB101360023040	90	40	40	2,32
23	148,1	139,90	SB101360023042	90	42	40	2,27
23	148,1	139,90	SB101360023045	90	45	40	2,21

Z	de	dp	codice	dm	D1	A	Kg.
23	148,1	139,90	SB101360023048	90	48	40	2,15
23	148,1	139,90	SB101360023050	90	50	40	2,10
24	154,1	145,94	SB101360024025	70	25	40	2,14
24	154,1	145,94	SB101360024028	80	28	40	2,37
24	154,1	145,94	SB101360024030	80	30	40	2,32
24	154,1	145,94	SB101360024032	90	32	40	2,60
24	154,1	145,94	SB101360024035	90	35	40	2,54
24	154,1	145,94	SB101360024038	90	38	40	2,49
24	154,1	145,94	SB101360024040	90	40	40	2,44
24	154,1	145,94	SB101360024042	90	42	40	2,39
24	154,1	145,94	SB101360024045	90	45	40	2,34
24	154,1	145,94	SB101360024048	90	48	40	2,28
24	154,1	145,94	SB101360024050	90	50	40	2,23
25	160,2	152,00	SB101360025025	70	25	40	2,25
25	160,2	152,00	SB101360025028	80	28	40	2,51
25	160,2	152,00	SB101360025030	80	30	40	2,45
25	160,2	152,00	SB101360025032	90	32	40	2,71
25	160,2	152,00	SB101360025035	90	35	40	2,67
25	160,2	152,00	SB101360025038	90	38	40	2,62
25	160,2	152,00	SB101360025040	90	40	40	2,58
25	160,2	152,00	SB101360025042	90	42	40	2,52
25	160,2	152,00	SB101360025045	90	45	40	2,46
25	160,2	152,00	SB101360025048	90	48	40	2,41
25	160,2	152,00	SB101360025050	90	50	40	2,36



1" x 17,02 mm
25,4 x 17,02 mm
Rullo 15,88 mm
16B-1

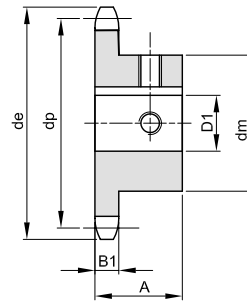
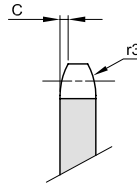

B1	C	r3
16,2	2,5	26

Materiale: Acciaio C45

Z	de	dp	codice	dm	D1	A	Kg.
11	101,7	90,14	SB101380011025	61	25	40	1,12
11	101,7	90,14	SB101380011028	61	28	40	1,09
11	101,7	90,14	SB101380011030	61	30	40	1,06
11	101,7	90,14	SB101380011032	61	32	40	1,02
11	101,7	90,14	SB101380011035	61	35	40	0,98
11	101,7	90,14	SB101380011038	65	38	40	0,97
11	101,7	90,14	SB101380011040	67	40	40	0,99
11	101,7	90,14	SB101380011042	67	42	40	0,97
12	109,7	98,14	SB101380012025	69	25	40	1,42
12	109,7	98,14	SB101380012028	69	28	40	1,39
12	109,7	98,14	SB101380012030	69	30	40	1,35
12	109,7	98,14	SB101380012032	69	32	40	1,31
12	109,7	98,14	SB101380012035	69	35	40	1,27
12	109,7	98,14	SB101380012038	69	38	40	1,22
12	109,7	98,14	SB101380012040	69	40	40	1,17
12	109,7	98,14	SB101380012042	69	42	40	1,13
13	117,7	106,12	SB101380013025	70	25	40	1,59
13	117,7	106,12	SB101380013028	78	28	40	1,61
13	117,7	106,12	SB101380013030	78	30	40	1,63
13	117,7	106,12	SB101380013032	78	32	40	1,62
13	117,7	106,12	SB101380013035	78	35	40	1,61
13	117,7	106,12	SB101380013038	78	38	40	1,56
13	117,7	106,12	SB101380013040	78	40	40	1,51
13	117,7	106,12	SB101380013042	78	42	40	1,48
13	117,7	106,12	SB101380013045	78	45	40	1,45
13	117,7	106,12	SB101380013048	78	48	40	1,41
13	117,7	106,12	SB101380013050	78	50	40	1,37
14	125,7	114,15	SB101380014025	70	25	40	1,83
14	125,7	114,15	SB101380014028	80	28	40	1,95
14	125,7	114,15	SB101380014030	80	30	40	1,92
14	125,7	114,15	SB101380014032	80	32	40	1,89
14	125,7	114,15	SB101380014035	84	35	40	1,91
14	125,7	114,15	SB101380014038	84	38	40	1,86
14	125,7	114,15	SB101380014040	84	40	40	1,83
14	125,7	114,15	SB101380014042	84	42	40	1,75
14	125,7	114,15	SB101380014045	84	45	40	1,71
14	125,7	114,15	SB101380014048	84	48	40	1,66
14	125,7	114,15	SB101380014050	84	50	40	1,61
15	133,7	122,17	SB101380015025	70	25	40	1,94
15	133,7	122,17	SB101380015028	80	28	40	2,12
15	133,7	122,17	SB101380015030	80	30	40	2,09
15	133,7	122,17	SB101380015032	80	32	40	2,03
15	133,7	122,17	SB101380015035	92	35	40	2,30

Z	de	dp	codice	dm	D1	A	Kg.
15	133,7	122,17	SB101380015038	92	38	40	2,25
15	133,7	122,17	SB101380015040	92	40	40	2,21
15	133,7	122,17	SB101380015042	92	42	40	2,15
15	133,7	122,17	SB101380015045	92	45	40	2,08
15	133,7	122,17	SB101380015048	92	48	40	2,03
15	133,7	122,17	SB101380015050	92	50	40	1,99
16	141,8	130,20	SB101380016025	80	25	45	2,59
16	141,8	130,20	SB101380016028	80	28	45	2,50
16	141,8	130,20	SB101380016030	80	30	45	2,47
16	141,8	130,20	SB101380016032	100	32	45	3,09
16	141,8	130,20	SB101380016035	100	35	45	3,01
16	141,8	130,20	SB101380016038	100	38	45	2,94
16	141,8	130,20	SB101380016040	100	40	45	2,89
16	141,8	130,20	SB101380016042	100	42	45	2,84
16	141,8	130,20	SB101380016045	100	45	45	2,78
16	141,8	130,20	SB101380016048	100	48	45	2,70
16	141,8	130,20	SB101380016050	100	50	45	2,65
17	149,8	138,22	SB101380017025	80	25	45	2,75
17	149,8	138,22	SB101380017028	80	28	45	2,70
17	149,8	138,22	SB101380017030	80	30	45	2,67
17	149,8	138,22	SB101380017032	100	32	45	3,30
17	149,8	138,22	SB101380017035	100	35	45	3,21
17	149,8	138,22	SB101380017038	100	38	45	3,15
17	149,8	138,22	SB101380017040	100	40	45	3,09
17	149,8	138,22	SB101380017042	100	42	45	3,02
17	149,8	138,22	SB101380017045	100	45	45	2,97
17	149,8	138,22	SB101380017048	100	48	45	2,91
17	149,8	138,22	SB101380017050	100	50	45	2,84
18	157,8	146,28	SB101380018025	80	25	45	2,97
18	157,8	146,28	SB101380018028	80	28	45	2,92
18	157,8	146,28	SB101380018030	80	30	45	2,89
18	157,8	146,28	SB101380018032	100	32	45	3,47
18	157,8	146,28	SB101380018035	100	35	45	3,42
18	157,8	146,28	SB101380018038	100	38	45	3,37
18	157,8	146,28	SB101380018040	100	40	45	3,32
18	157,8	146,28	SB101380018042	100	42	45	3,25
18	157,8	146,28	SB101380018045	100	45	45	3,19
18	157,8	146,28	SB101380018048	100	48	45	3,12
18	157,8	146,28	SB101380018050	100	50	45	3,06
19	165,9	154,33	SB101380019025	80	25	45	3,21
19	165,9	154,33	SB101380019028	80	28	45	3,18
19	165,9	154,33	SB101380019030	80	30	45	3,12
19	165,9	154,33	SB101380019032	100	32	45	3,71



1" x 17,02 mm
25,4 x 17,02 mm
Rullo 15,88 mm
16B-1

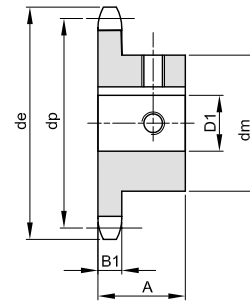
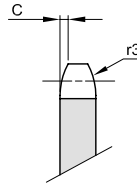

B1	C	r3
16,2	2,5	26

Materiale: Acciaio C45

Z	de	dp	codice	dm	D1	A	Kg.
19	165,9	154,33	SB101380019035	100	35	45	3,67
19	165,9	154,33	SB101380019038	100	38	45	3,61
19	165,9	154,33	SB101380019040	100	40	45	3,56
19	165,9	154,33	SB101380019042	100	42	45	3,51
19	165,9	154,33	SB101380019045	100	45	45	3,46
19	165,9	154,33	SB101380019048	100	48	45	3,38
19	165,9	154,33	SB101380019050	100	50	45	3,30
20	173,9	162,38	SB101380020025	80	25	45	3,46
20	173,9	162,38	SB101380020028	80	28	45	3,41
20	173,9	162,38	SB101380020030	80	30	45	3,37
20	173,9	162,38	SB101380020032	100	32	45	3,95
20	173,9	162,38	SB101380020035	100	35	45	3,90
20	173,9	162,38	SB101380020038	100	38	45	3,84
20	173,9	162,38	SB101380020040	100	40	45	3,79
20	173,9	162,38	SB101380020042	100	42	45	3,72
20	173,9	162,38	SB101380020045	100	45	45	3,65
20	173,9	162,38	SB101380020048	100	48	45	3,60
20	173,9	162,38	SB101380020050	100	50	45	3,55
21	182,0	170,43	SB101380021025	80	25	50	3,92
21	182,0	170,43	SB101380021028	80	28	50	3,86
21	182,0	170,43	SB101380021030	80	30	50	3,81
21	182,0	170,43	SB101380021032	100	32	50	4,52
21	182,0	170,43	SB101380021035	100	35	50	4,45
21	182,0	170,43	SB101380021038	100	38	50	4,38
21	182,0	170,43	SB101380021040	110	40	50	4,75
21	182,0	170,43	SB101380021042	110	42	50	4,70
21	182,0	170,43	SB101380021045	110	45	50	4,63
21	182,0	170,43	SB101380021048	110	48	50	4,54
21	182,0	170,43	SB101380021050	110	50	50	4,48
22	190,1	178,48	SB101380022025	80	25	50	4,19
22	190,1	178,48	SB101380022028	80	28	50	4,13
22	190,1	178,48	SB101380022030	80	30	50	4,08
22	190,1	178,48	SB101380022032	100	32	50	4,79
22	190,1	178,48	SB101380022035	100	35	50	4,72
22	190,1	178,48	SB101380022038	100	38	50	4,66
22	190,1	178,48	SB101380022040	110	40	50	5,04
22	190,1	178,48	SB101380022042	110	42	50	5,00
22	190,1	178,48	SB101380022045	110	45	50	4,94
22	190,1	178,48	SB101380022048	110	48	50	4,88
22	190,1	178,48	SB101380022050	110	50	50	4,82
23	198,1	186,53	SB101380023025	80	25	50	4,48
23	198,1	186,53	SB101380023028	80	28	50	4,42
23	198,1	186,53	SB101380023030	80	30	50	4,35

Z	de	dp	codice	dm	D1	A	Kg.
23	198,1	186,53	SB101380023032	100	32	50	5,08
23	198,1	186,53	SB101380023035	100	35	50	5,01
23	198,1	186,53	SB101380023038	100	38	50	4,93
23	198,1	186,53	SB101380023040	110	40	50	5,32
23	198,1	186,53	SB101380023042	110	42	50	5,28
23	198,1	186,53	SB101380023045	110	45	50	5,22
23	198,1	186,53	SB101380023048	110	48	50	5,17
23	198,1	186,53	SB101380023050	110	50	50	5,11
24	206,2	194,59	SB101380024025	80	25	50	4,79
24	206,2	194,59	SB101380024028	80	28	50	4,73
24	206,2	194,59	SB101380024030	80	30	50	4,68
24	206,2	194,59	SB101380024032	100	32	50	5,37
24	206,2	194,59	SB101380024035	100	35	50	5,31
24	206,2	194,59	SB101380024038	100	38	50	5,26
24	206,2	194,59	SB101380024040	110	40	50	5,63
24	206,2	194,59	SB101380024042	110	42	50	5,54
24	206,2	194,59	SB101380024045	110	45	50	5,46
24	206,2	194,59	SB101380024048	110	48	50	5,39
24	206,2	194,59	SB101380024050	110	50	50	5,32
25	214,2	202,66	SB101380025025	80	25	50	5,11
25	214,2	202,66	SB101380025028	80	28	50	5,04
25	214,2	202,66	SB101380025030	80	30	50	4,97
25	214,2	202,66	SB101380025032	100	32	50	5,67
25	214,2	202,66	SB101380025035	100	35	50	5,60
25	214,2	202,66	SB101380025038	100	38	50	5,53
25	214,2	202,66	SB101380025040	110	40	50	5,92
25	214,2	202,66	SB101380025042	110	42	50	5,84
25	214,2	202,66	SB101380025045	110	45	50	5,77
25	214,2	202,66	SB101380025048	110	48	50	5,70
25	214,2	202,66	SB101380025050	110	50	50	5,64



PIGNONI DOPPI PER CATENE A RULLI "SYSTEM BEA" - DIN 8187 - ISO 606
DUPLEX SPROCKETS FOR ROLLER CHAINS "SYSTEM BEA" - DIN 8187 - ISO 606

3/8" x 7/32"
9,525 x 5,72 mm
Rullo 6,35 mm
06B-2

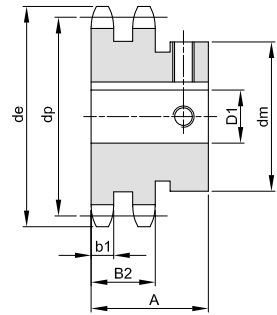
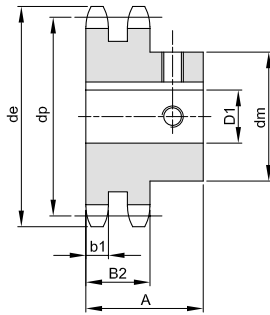
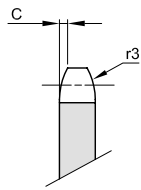

TIPO *

B1	B2	B3	b1	C	r3
15,4	5,2	1	10		

Materiale: Acciaio C45

Z	de	dp	codice	dm	D1	A	Kg.
11	37,5	33,80	SB102330011010	24	10	35	0,12
11	37,5	33,80	SB102330011012	26*	12	35	0,12
11	37,5	33,80	SB102330011014	29*	14	35	0,12
11	37,5	33,80	SB102330011015	30*	15	35	0,12
12	40,5	36,80	SB102330012010	25	10	35	0,14
12	40,5	36,80	SB102330012012	26	12	35	0,14
12	40,5	36,80	SB102330012014	29*	14	35	0,14
12	40,5	36,80	SB102330012015	30*	15	35	0,14
12	40,5	36,80	SB102330012016	31*	16	35	0,14
13	43,5	39,80	SB102330013010	28	10	35	0,18
13	43,5	39,80	SB102330013012	28	12	35	0,17
13	43,5	39,80	SB102330013014	29	14	35	0,17
13	43,5	39,80	SB102330013015	30	15	35	0,17
14	46,5	42,80	SB102330014014	31	14	35	0,20
14	46,5	42,80	SB102330014015	31	15	35	0,20
14	46,5	42,80	SB102330014016	31	16	35	0,19
14	46,5	42,80	SB102330014019	35*	19	35	0,19
15	49,5	45,81	SB102330015014	34	14	35	0,25
15	49,5	45,81	SB102330015015	34	15	35	0,24
15	49,5	45,81	SB102330015016	34	16	35	0,24
15	49,5	45,81	SB102330015020	36	20	35	0,22
15	49,5	45,81	SB102330015025	42*	25	35	0,20
16	52,5	48,82	SB102330016012	37	12	38	0,33
16	52,5	48,82	SB102330016015	37	15	38	0,31
16	52,5	48,82	SB102330016020	37	20	38	0,27
16	52,5	48,82	SB102330016025	42*	25	38	0,25
17	55,5	51,83	SB102330017012	40	12	38	0,39
17	55,5	51,83	SB102330017015	40	15	38	0,37
17	55,5	51,83	SB102330017020	40	20	38	0,33
17	55,5	51,83	SB102330017025	42	25	38	0,29
18	58,6	54,85	SB102330018012	43	12	38	0,45
18	58,6	54,85	SB102330018015	43	15	38	0,43
18	58,6	54,85	SB102330018020	43	20	38	0,39
18	58,6	54,85	SB102330018025	43	25	38	0,33
19	61,6	57,87	SB102330019012	45	12	38	0,50
19	61,6	57,87	SB102330019015	45	15	38	0,48
19	61,6	57,87	SB102330019016	45	16	38	0,48
19	61,6	57,87	SB102330019020	45	20	38	0,44
19	61,6	57,87	SB102330019025	45	25	38	0,38
20	64,6	60,89	SB102330020012	46	12	38	0,55
20	64,6	60,89	SB102330020015	46	15	38	0,53
20	64,6	60,89	SB102330020016	46	16	38	0,52
20	64,6	60,89	SB102330020020	46	20	38	0,48

Z	de	dp	codice	dm	D1	A	Kg.
20	64,6	60,89	SB102330020025	46	25	38	0,43
21	67,6	63,91	SB102330021015	48	15	38	0,59
21	67,6	63,91	SB102330021016	48	16	38	0,58
21	67,6	63,91	SB102330021020	48	20	38	0,54
21	67,6	63,91	SB102330021025	48	25	38	0,49
22	70,6	66,93	SB102330022020	50	20	38	0,60
22	70,6	66,93	SB102330022025	50	25	38	0,55
23	73,7	69,95	SB102330023015	52	15	38	0,71
23	73,7	69,95	SB102330023016	52	16	38	0,70
23	73,7	69,95	SB102330023020	52	20	38	0,67
23	73,7	69,95	SB102330023025	52	25	38	0,61
24	76,7	72,97	SB102330024020	54	20	38	0,73
24	76,7	72,97	SB102330024025	54	25	38	0,68
25	79,7	76,00	SB102330025016	57	16	38	0,86
25	79,7	76,00	SB102330025020	57	20	38	0,82
25	79,7	76,00	SB102330025025	57	25	38	0,76
25	79,7	76,00	SB102330025030	57	30	38	0,70
30	94,8	91,12	SB102330030020	60	20	40	1,13
30	94,8	91,12	SB102330030025	60	25	40	1,07
30	94,8	91,12	SB102330030030	60	30	40	1,01



PIGNONI DOPPI PER CATENE A RULLI "SYSTEM BEA" - DIN 8187 - ISO 606
DUPLEX SPROCKETS FOR ROLLER CHAINS "SYSTEM BEA" - DIN 8187 - ISO 606

1/2" x 5/16"
12,7 x 7,75 mm
Rullo 8,51 mm
08B-2

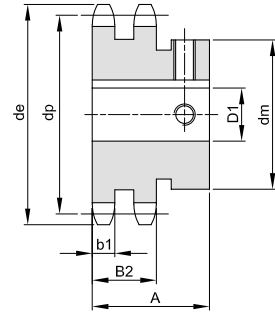
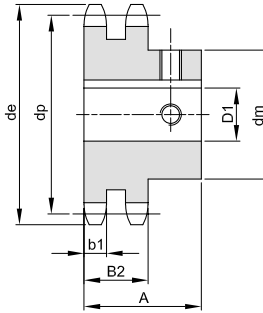
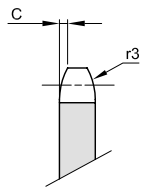

TIPO *

B1	B2	B3	b1	C	r3
21			7	1,3	13

Materiale: Acciaio C45

Z	de	dp	codice	dm	D1	A	Kg.
11	49,9	45,07	SB102340011012	29	12	39	0,24
11	49,9	45,07	SB102340011014	29	14	39	0,23
11	49,9	45,07	SB102340011015	30	15	39	0,23
11	49,9	45,07	SB102340011016	31	16	39	0,22
12	53,9	49,07	SB102340012012	33	12	42	0,33
12	53,9	49,07	SB102340012014	33	14	42	0,31
12	53,9	49,07	SB102340012015	33	15	42	0,30
12	53,9	49,07	SB102340012016	33	16	42	0,29
13	57,9	56,06	SB102340013014	37	14	42	0,39
13	57,9	56,06	SB102340013015	37	15	42	0,38
13	57,9	56,06	SB102340013016	37	16	42	0,38
13	57,9	56,06	SB102340013020	37	20	42	0,34
13	57,9	56,06	SB102340013025	42*	25	42	0,31
14	61,9	57,07	SB102340014015	41	15	42	0,47
14	61,9	57,07	SB102340014016	41	16	42	0,46
14	61,9	57,07	SB102340014020	41	20	42	0,43
14	61,9	57,07	SB102340014025	41	25	42	0,36
15	65,9	61,09	SB102340015015	45	15	42	0,57
15	65,9	61,09	SB102340015016	45	16	42	0,56
15	65,9	61,09	SB102340015020	45	20	42	0,52
15	65,9	61,09	SB102340015025	45	25	42	0,46
15	65,9	61,09	SB102340015030	47	30	42	0,41
16	69,9	65,10	SB102340016016	50	16	42	0,68
16	69,9	65,10	SB102340016018	50	18	42	0,66
16	69,9	65,10	SB102340016020	50	20	42	0,64
16	69,9	65,10	SB102340016025	50	25	42	0,58
17	74,0	69,11	SB102340017016	52	16	42	0,77
17	74,0	69,11	SB102340017018	52	18	42	0,75
17	74,0	69,11	SB102340017020	52	20	42	0,73
17	74,0	69,11	SB102340017025	52	25	42	0,67
17	74,0	69,11	SB102340017030	52	30	42	0,60
18	78,0	73,14	SB102340018020	56	20	42	0,85
18	78,0	73,14	SB102340018025	56	25	42	0,79
18	78,0	73,14	SB102340018030	56	30	42	0,72
18	78,0	73,14	SB102340018035	56	35	42	0,63
19	82,0	77,16	SB102340019020	60	20	42	0,98
19	82,0	77,16	SB102340019025	60	25	42	0,92
19	82,0	77,16	SB102340019030	60	30	42	0,85
19	82,0	77,16	SB102340019035	60	35	42	0,76
20	86,0	81,19	SB102340020020	64	20	42	1,12
20	86,0	81,19	SB102340020025	64	25	42	1,06
20	86,0	81,19	SB102340020030	64	30	42	0,99
20	86,0	81,19	SB102340020035	64	35	42	0,90
21	90,1	85,22	SB102340021020	68	20	42	1,27
21	90,1	85,22	SB102340021025	68	25	42	1,20

Z	de	dp	codice	dm	D1	A	Kg.
21	90,1	85,22	SB102340021030	68	30	42	1,13
21	90,1	85,22	SB102340021035	68	35	42	1,05
22	94,1	89,24	SB102340022020	70	20	42	1,38
22	94,1	89,24	SB102340022025	70	25	42	1,32
23	98,1	93,27	SB102340023020	70	20	42	1,47
23	98,1	93,27	SB102340023025	70	25	42	1,41
23	98,1	93,27	SB102340023030	70	30	42	1,34
24	102,1	97,29	SB102340024020	70	20	42	1,57
24	102,1	97,29	SB102340024025	70	25	42	1,51
25	106,2	101,33	SB102340025020	70	20	42	1,66
25	106,2	101,33	SB102340025025	70	25	42	1,60
25	106,2	101,33	SB102340025030	70	30	42	1,53
30	126,3	121,50	SB102340030025	80	25	44	2,40
30	126,3	121,50	SB102340030030	80	30	44	2,32
30	126,3	121,50	SB102340030035	80	35	44	2,23



PIGNONI DOPPI PER CATENE A RULLI "SYSTEM BEA" - DIN 8187 - ISO 606
DUPLEX SPROCKETS FOR ROLLER CHAINS "SYSTEM BEA" - DIN 8187 - ISO 606

5/8" x 3/8"
15,875 x 9,65 mm
 Rullo 10,16 mm
10B-2

B1	B2	B3	b1	C	r3
25,5			9	1,6	16

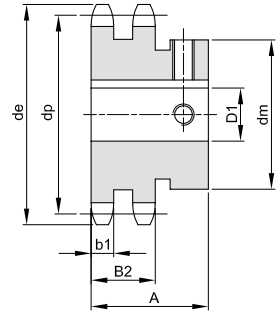
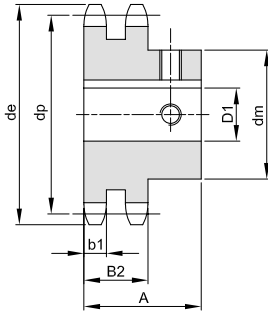
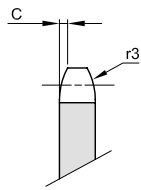

TIPO *

Materiale: Acciaio C45

Z	de	dp	codice	dm	D1	A	Kg.
11	63,2	56,34	SB102350011020	37	20	45	0,43
11	63,2	56,34	SB102350011025	42*	25	45	0,40
11	63,2	56,34	SB102350011030	45*	30	45	0,35
12	68,2	61,34	SB102350012020	42	20	45	0,56
12	68,2	61,34	SB102350012025	44	25	45	0,51
12	68,2	61,34	SB102350012030	49*	30	45	0,47
13	73,2	66,32	SB102350013020	47	20	45	0,70
13	73,2	66,32	SB102350013025	47	25	45	0,63
13	73,2	66,32	SB102350013030	49	30	45	0,58
14	78,2	71,34	SB102350014020	52	20	45	0,85
14	78,2	71,34	SB102350014025	52	25	45	0,78
14	78,2	71,34	SB102350014030	52	30	45	0,71
15	83,2	76,36	SB102350015020	57	20	45	1,02
15	83,2	76,36	SB102350015025	57	25	45	0,95
15	83,2	76,36	SB102350015030	57	30	45	0,88
15	83,2	76,36	SB102350015035	57	35	45	0,78
16	88,3	81,37	SB102350016020	60	20	45	1,17
16	88,3	81,37	SB102350016025	60	25	45	1,11
16	88,3	81,37	SB102350016030	60	30	45	1,03
16	88,3	81,37	SB102350016035	60	35	45	0,94
17	93,3	86,39	SB102350017020	60	20	45	1,29
17	93,3	86,39	SB102350017025	60	25	45	1,23
17	93,3	86,39	SB102350017030	60	30	45	1,15
17	93,3	86,39	SB102350017035	60	35	45	1,06
18	98,3	91,42	SB102350018020	70	20	45	1,58
18	98,3	91,42	SB102350018025	70	25	45	1,51
18	98,3	91,42	SB102350018030	70	30	45	1,44
18	98,3	91,42	SB102350018035	70	35	45	1,34
18	98,3	91,42	SB102350018040	70	40	45	1,23
19	103,3	96,45	SB102350019020	70	20	45	1,71
19	103,3	96,45	SB102350019025	70	25	45	1,65
19	103,3	96,45	SB102350019030	70	30	45	1,57
19	103,3	96,45	SB102350019035	70	35	45	1,48
19	103,3	96,45	SB102350019040	70	40	45	1,37
20	108,4	101,49	SB102350020020	75	20	45	1,94
20	108,4	101,49	SB102350020025	75	25	45	1,88
20	108,4	101,49	SB102350020030	75	30	45	1,80
20	108,4	101,49	SB102350020035	75	35	45	1,71
20	108,4	101,49	SB102350020040	75	40	45	1,60
21	113,4	106,52	SB102350021020	75	20	45	2,10
21	113,4	106,52	SB102350021025	75	25	45	2,03
21	113,4	106,52	SB102350021030	75	30	45	1,95
21	113,4	106,52	SB102350021035	75	35	45	1,86

Z	de	dp	codice	dm	D1	A	Kg.
21	113,4	106,52	SB102350021040	75	40	45	1,75
22	118,4	111,55	SB102350022020	80	20	45	2,35
22	118,4	111,55	SB102350022025	80	25	45	2,28
22	118,4	111,55	SB102350022030	80	30	45	2,21
23	123,5	116,58	SB102350023020	80	20	45	2,52
23	123,5	116,58	SB102350023025	80	25	45	2,45
23	123,5	116,58	SB102350023030	80	30	45	2,37
23	123,5	116,58	SB102350023035	80	35	45	2,28
23	123,5	116,58	SB102350023040	80	40	45	2,17
24	128,5	121,62	SB102350024020	80	20	45	2,69
24	128,5	121,62	SB102350024025	80	25	45	2,63
24	128,5	121,62	SB102350024030	80	30	45	2,55
25	133,6	126,66	SB102350025025	80	25	45	2,81
25	133,6	126,66	SB102350025030	80	30	45	2,74
25	133,6	126,66	SB102350025035	80	35	45	2,64
25	133,6	126,66	SB102350025040	80	40	45	2,53



PIGNONI DOPPI PER CATENE A RULLI "SYSTEM BEA" - DIN 8187 - ISO 606
DUPLEX SPROCKETS FOR ROLLER CHAINS "SYSTEM BEA" - DIN 8187 - ISO 606

3/4" x 7/16"
19,05 x 11,68 mm
 Rullo 12,07 mm
12B-2

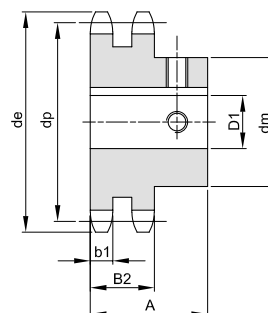
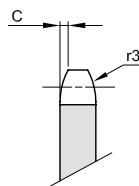

B1	B2	B3	b1	C	r3
30,3			10,8	2	19

Materiale: Acciaio C45

Z	de	dp	codice	dm	D1	A	Kg.
11	75,8	67,61	SB102360011020	46	20	54	0,82
11	75,8	67,61	SB102360011025	46	25	54	0,74
11	75,8	67,61	SB102360011030	51	30	54	0,72
12	81,8	73,60	SB102360012020	52	20	54	1,04
12	81,8	73,60	SB102360012025	52	25	54	0,96
12	81,8	73,60	SB102360012030	52	30	54	0,87
12	81,8	73,60	SB102360012035	56	35	54	0,82
13	87,8	79,59	SB102360013020	58	20	54	1,28
13	87,8	79,59	SB102360013025	58	25	54	1,20
13	87,8	79,59	SB102360013030	58	30	54	1,11
13	87,8	79,59	SB102360013035	58	35	54	1,00
14	93,8	85,61	SB102360014020	64	20	54	1,56
14	93,8	85,61	SB102360014025	64	25	54	1,47
14	93,8	85,61	SB102360014030	64	30	54	1,38
14	93,8	85,61	SB102360014035	64	35	54	1,27
15	99,8	91,63	SB102360015020	70	20	54	1,85
15	99,8	91,63	SB102360015025	70	25	54	1,77
15	99,8	91,63	SB102360015030	70	30	54	1,68
15	99,8	91,63	SB102360015035	70	35	54	1,57
16	105,8	97,65	SB102360016025	75	25	54	2,07
16	105,8	97,65	SB102360016030	75	30	54	1,98
16	105,8	97,65	SB102360016035	75	35	54	1,87
16	105,8	97,65	SB102360016040	75	40	54	1,73
17	111,9	103,67	SB102360017025	80	25	54	2,39
17	111,9	103,67	SB102360017030	80	30	54	2,30
17	111,9	103,67	SB102360017035	80	35	54	2,18
17	111,9	103,67	SB102360017040	80	40	54	2,05
18	117,9	109,71	SB102360018025	80	25	54	2,61
18	117,9	109,71	SB102360018030	80	30	54	2,52
18	117,9	109,71	SB102360018035	80	35	54	2,40
18	117,9	109,71	SB102360018040	80	40	54	2,27
19	123,9	115,75	SB102360019025	80	25	54	2,84
19	123,9	115,75	SB102360019030	80	30	54	2,75
19	123,9	115,75	SB102360019035	80	35	54	2,64
19	123,9	115,75	SB102360019040	80	40	54	2,51
20	130,0	121,78	SB102360020025	80	25	54	3,09
20	130,0	121,78	SB102360020030	80	30	54	3,00
20	130,0	121,78	SB102360020035	80	35	54	2,88
20	130,0	121,78	SB102360020040	80	40	54	2,75
21	136,0	127,82	SB102360021025	90	25	59	3,82
21	136,0	127,82	SB102360021030	90	30	59	3,72
21	136,0	127,82	SB102360021035	90	35	59	3,59
21	136,0	127,82	SB102360021040	90	40	59	3,45

Z	de	dp	codice	dm	D1	A	Kg.
21	136,0	127,82	SB102360021045	90	45	59	3,29
22	142,0	133,86	SB102360022025	90	25	59	4,09
22	142,0	133,86	SB102360022030	90	30	59	3,99
22	142,0	133,86	SB102360022035	90	35	59	3,87
22	142,0	133,86	SB102360022040	90	40	59	3,72
23	148,1	139,90	SB102360023025	90	25	59	4,38
23	148,1	139,90	SB102360023030	90	30	59	4,29
23	148,1	139,90	SB102360023035	90	35	59	4,16
23	148,1	139,90	SB102360023040	90	40	59	4,02
23	148,1	139,90	SB102360023045	90	45	59	3,85
24	154,1	145,94	SB102360024025	90	25	59	4,68
24	154,1	145,94	SB102360024030	90	30	59	4,59
24	154,1	145,94	SB102360024035	90	35	59	4,46
24	154,1	145,94	SB102360024040	90	40	59	4,32
25	160,2	152,00	SB102360025025	90	25	59	5,00
25	160,2	152,00	SB102360025030	90	30	59	4,90
25	160,2	152,00	SB102360025035	90	35	59	4,77
25	160,2	152,00	SB102360025040	90	40	59	4,63



DATI TECNICI - TECHNICAL DATA

Temperati ad induzione sui denti (HRc 50)
Diametro fori in tolleranza H7 - Rugosità RA 1,6
Cave Linguette secondo DIN 6885 / UNI 6604 in asse al dente
N° 2 fori per viti di fissaggio

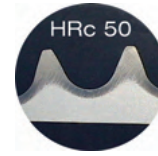

Teeth: inductioned hardness (HRc 50)
 Final bore tolerance H7 - Roughness value RA 1,6
 Keyway to DIN 6885 / BS 4235 is located on the center line of tooth
 Two grub screw holes

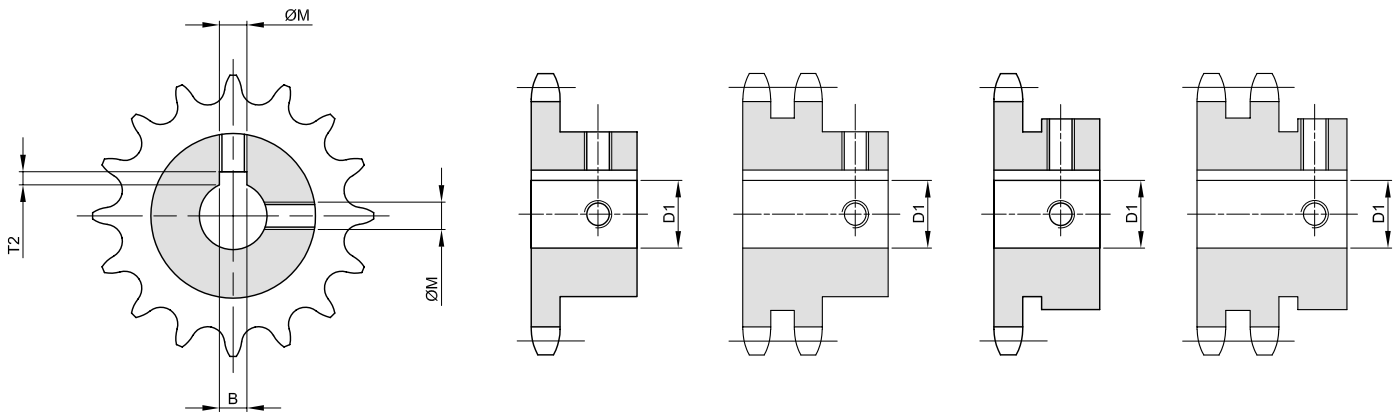

diametro fori D1		larghezza cava B		profondità cava T2		diametro vite Ø M
Ø10	H7 +0,015 -0	3	H9 +0,025 -0	1,4	+0,10 -0	M3
Ø12	H7 +0,018 -0	4	H9 +0,030 -0	1,8	+0,10 -0	M3
Ø14	H7 +0,018 -0	5	H9 +0,030 -0	2,3	+0,10 -0	M4
Ø15	H7 +0,018 -0	5	H9 +0,030 -0	2,3	+0,10 -0	M4
Ø16	H7 +0,018 -0	5	H9 +0,030 -0	2,3	+0,10 -0	M4
Ø18	H7 +0,018 -0	6	H9 +0,030 -0	2,8	+0,10 -0	M5
Ø19	H7 +0,021 -0	6	H9 +0,030 -0	2,8	+0,10 -0	M5
Ø20	H7 +0,021 -0	6	H9 +0,030 -0	2,8	+0,10 -0	M5
Ø22	H7 +0,021 -0	6	H9 +0,030 -0	2,8	+0,10 -0	M5
Ø24	H7 +0,021 -0	8	H9 +0,036 -0	3,3	+0,20 -0	M6
Ø25	H7 +0,021 -0	8	H9 +0,036 -0	3,3	+0,20 -0	M6
Ø28	H7 +0,021 -0	8	H9 +0,036 -0	3,3	+0,20 -0	M6
Ø30	H7 +0,021 -0	8	H9 +0,036 -0	3,3	+0,20 -0	M6
Ø32	H7 +0,025 -0	10	H9 +0,036 -0	3,3	+0,20 -0	M8
Ø35	H7 +0,025 -0	10	H9 +0,036 -0	3,3	+0,20 -0	M8
Ø38	H7 +0,025 -0	10	H9 +0,036 -0	3,3	+0,20 -0	M8
Ø40	H7 +0,025 -0	12	H9 +0,043 -0	3,3	+0,20 -0	M10
Ø42	H7 +0,025 -0	12	H9 +0,043 -0	3,3	+0,20 -0	M10
Ø45	H7 +0,025 -0	14	H9 +0,043 -0	3,8	+0,20 -0	M12
Ø48	H7 +0,025 -0	14	H9 +0,043 -0	3,8	+0,20 -0	M12
Ø50	H7 +0,025 -0	14	H9 +0,043 -0	3,8	+0,20 -0	M12